

Master Rigid E

600x600, 1200x600, 1200x1200

M317

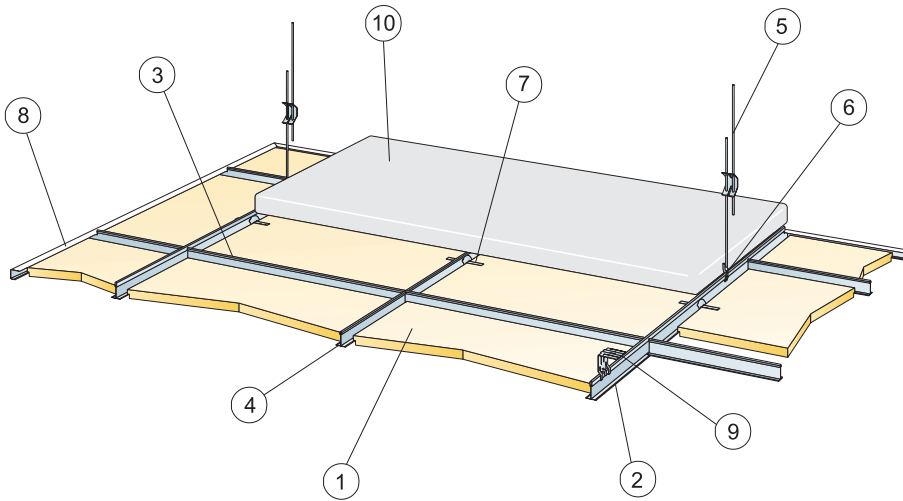
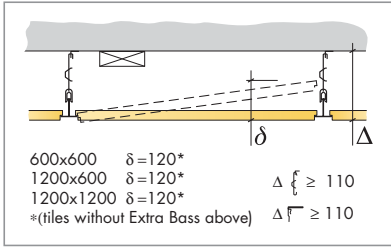

1. Ecophon Master Rigid E

2. Connect T24 Main runner

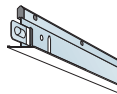

6. Connect Hanger clip



3. Connect T24 Cross tee, L=1200

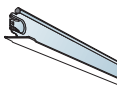

7. Connect Hold down clip E

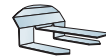

4. Connect T24 Cross tee, L=600

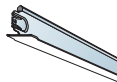

8. Connect Channel trim

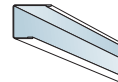

5. Connect Adjustable hanger



9. Connect Direct fixing bracket



10. Ecophon Extra Bass 1200x600x50

Demounting
600x600 → 30
1200x600 → 31
1200x1200 → 32

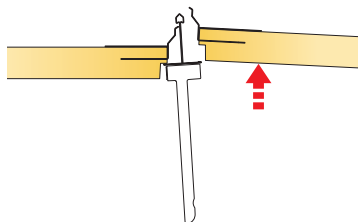

Ecophon[®]
SAINT-GOBAIN

A SOUND EFFECT ON PEOPLE

www.ecophon.com

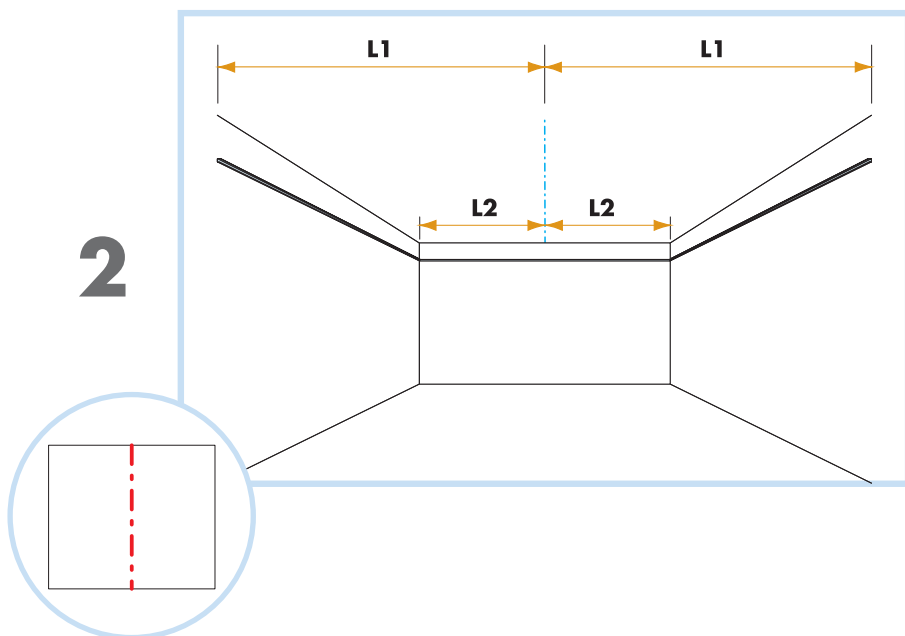
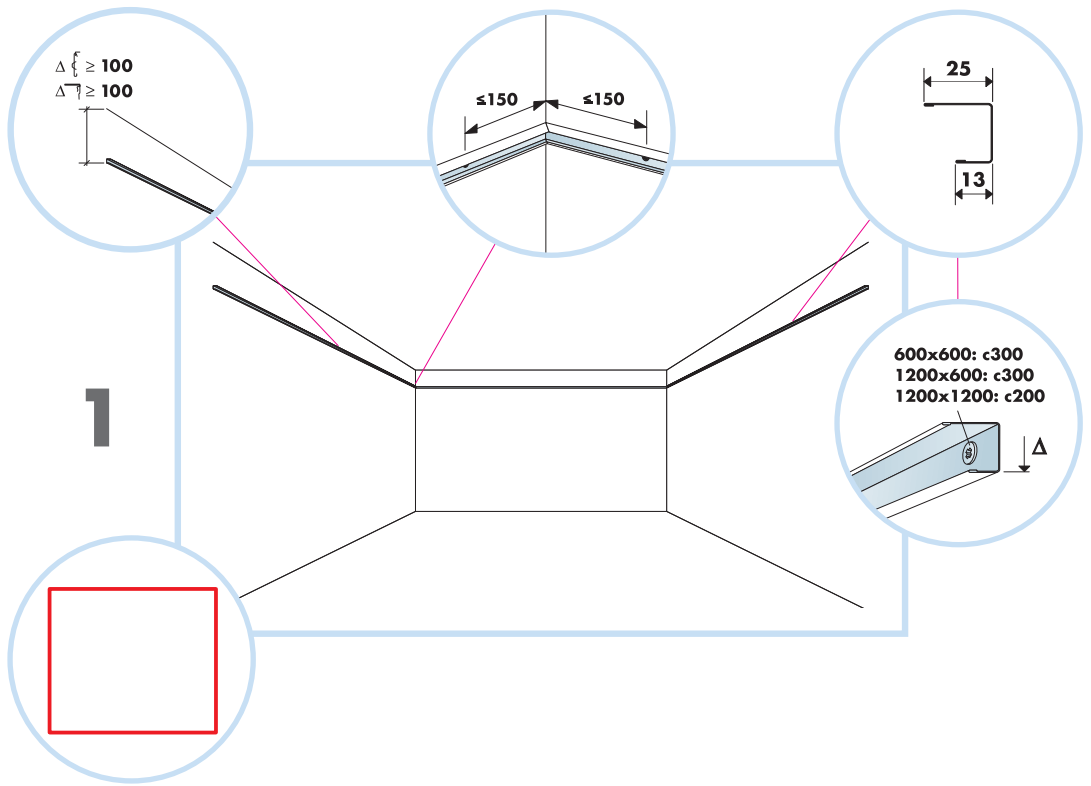

600x600 → 3
1200x600 → 3
1200x1200 → 19

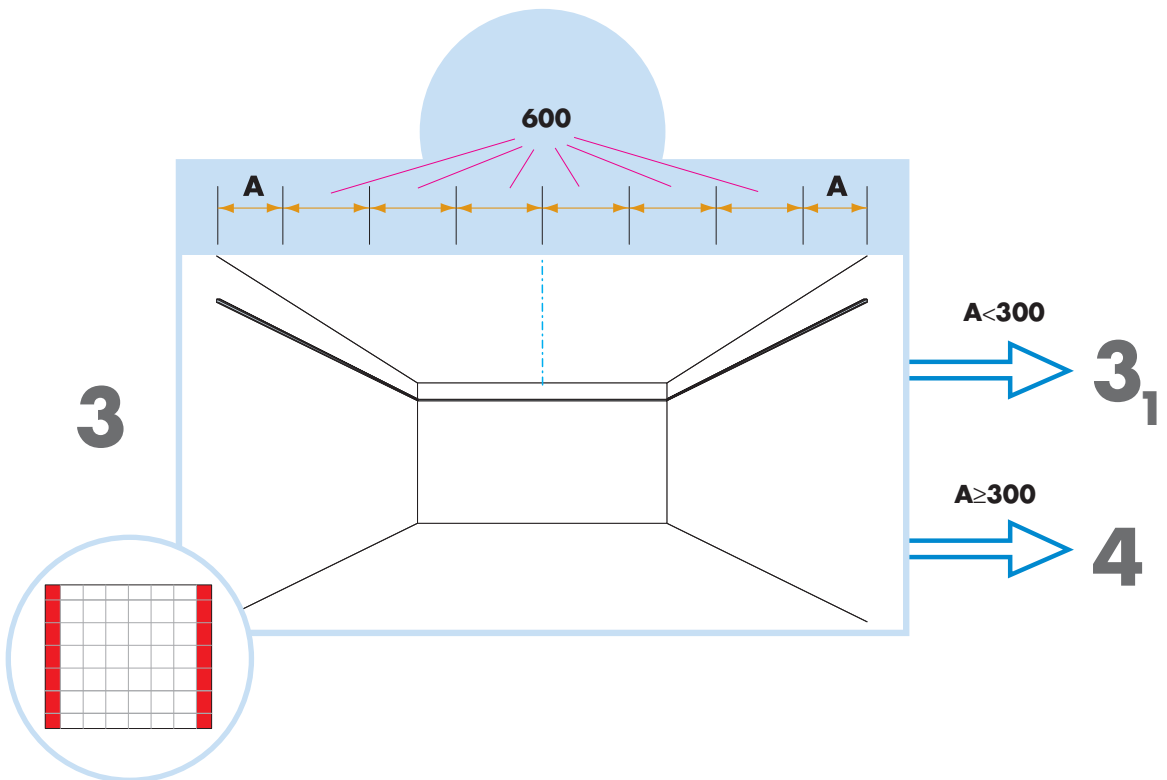

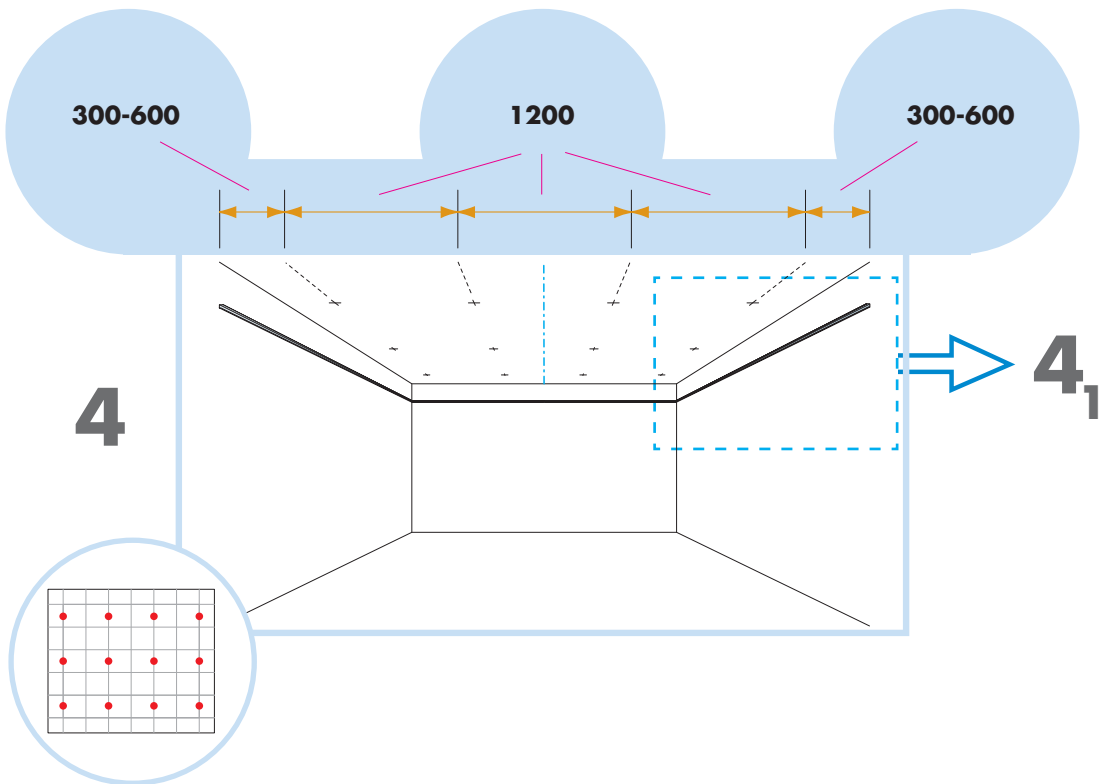
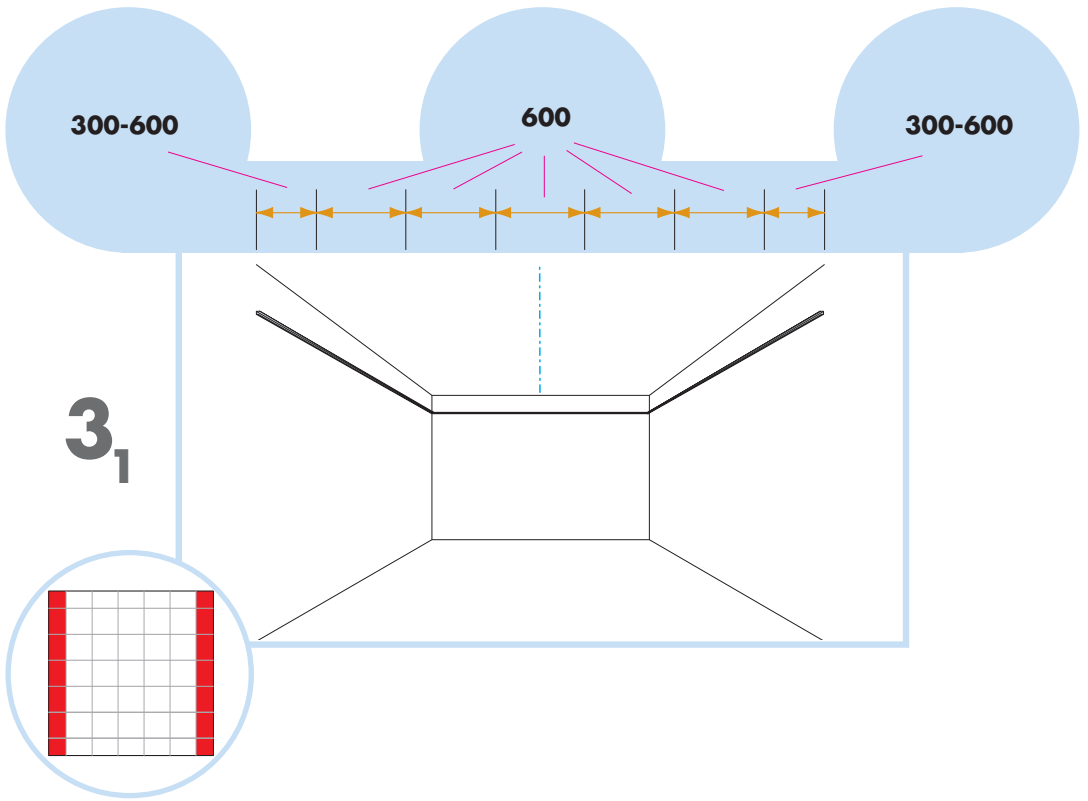

4₁

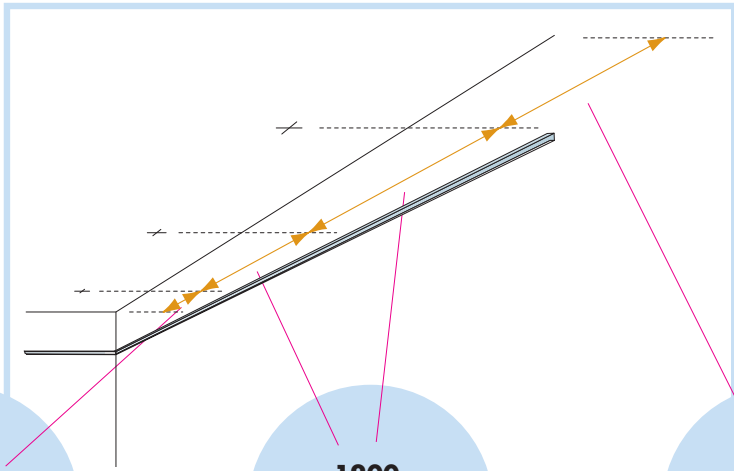

≤600

1200

≤600

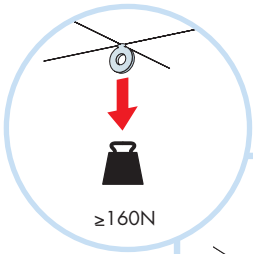

≥160N

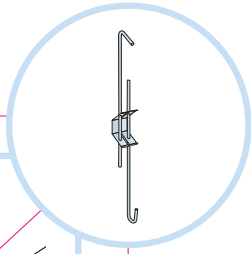
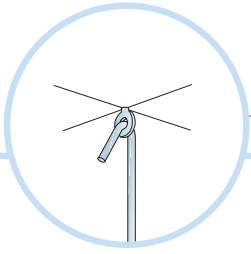

5

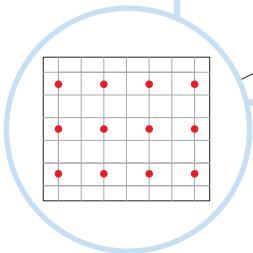
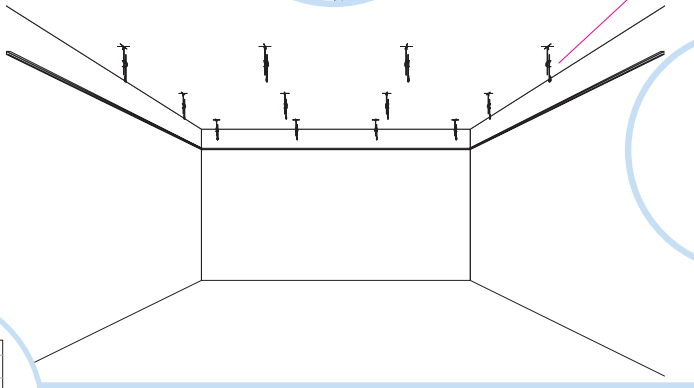

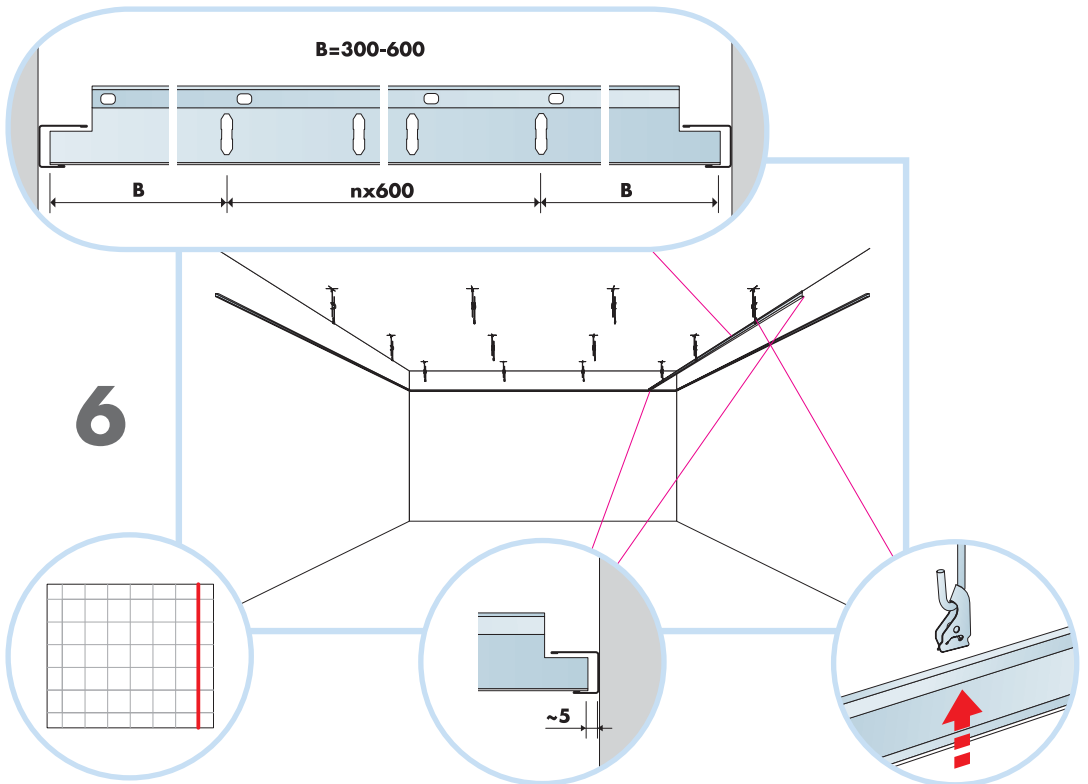
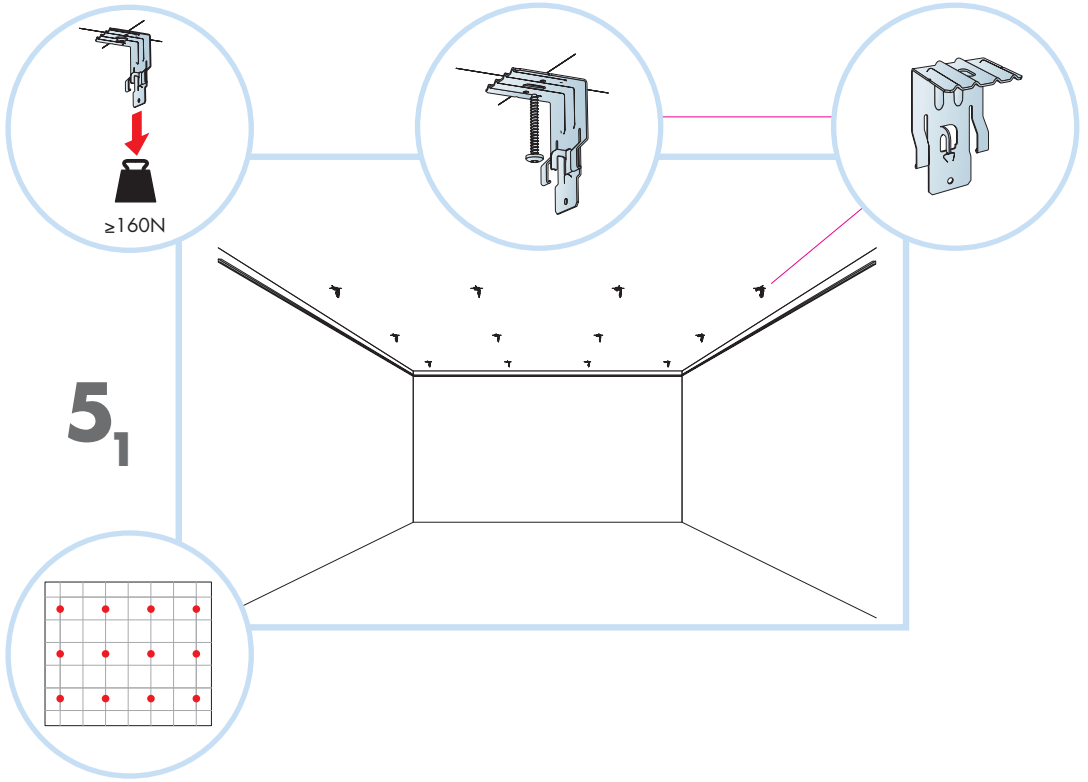

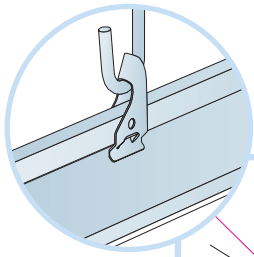

7

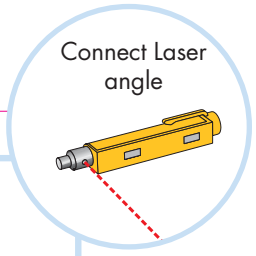
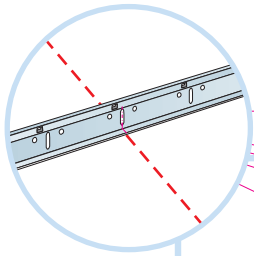
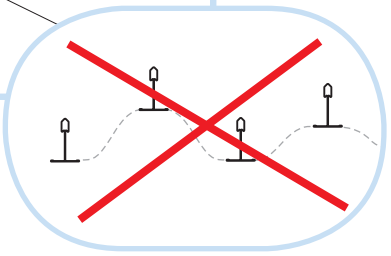
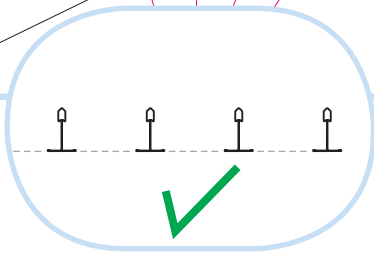
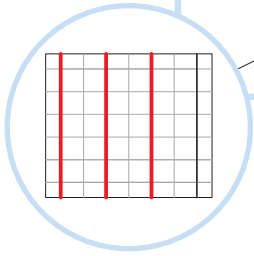
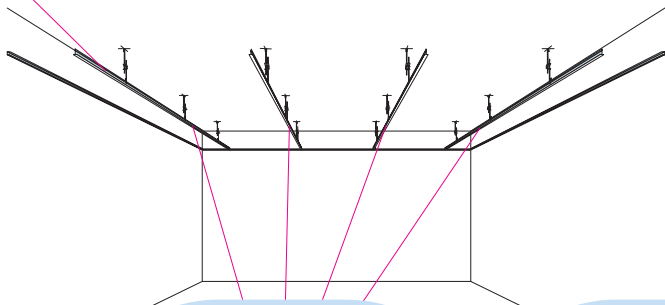

7₁

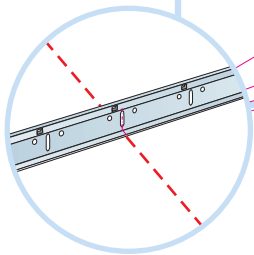
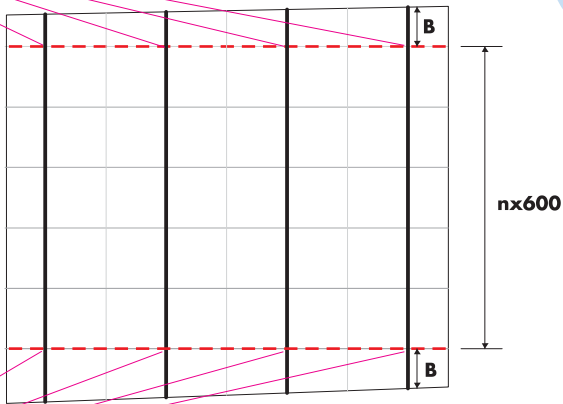

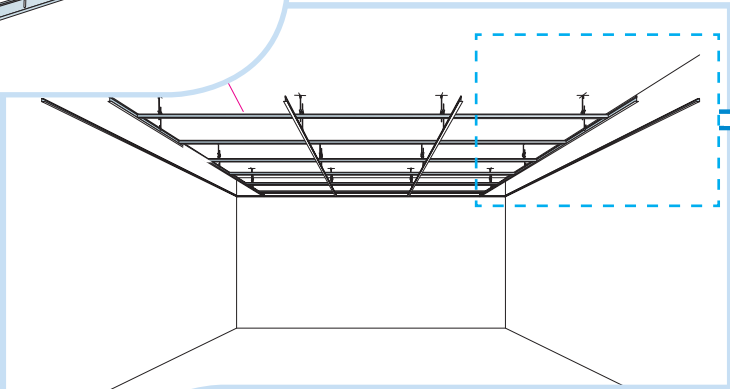
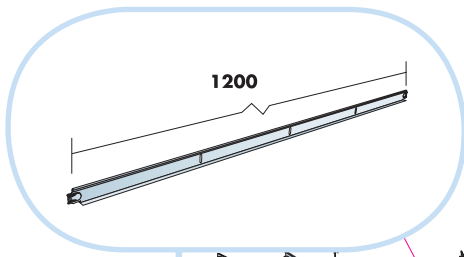

8₁

8

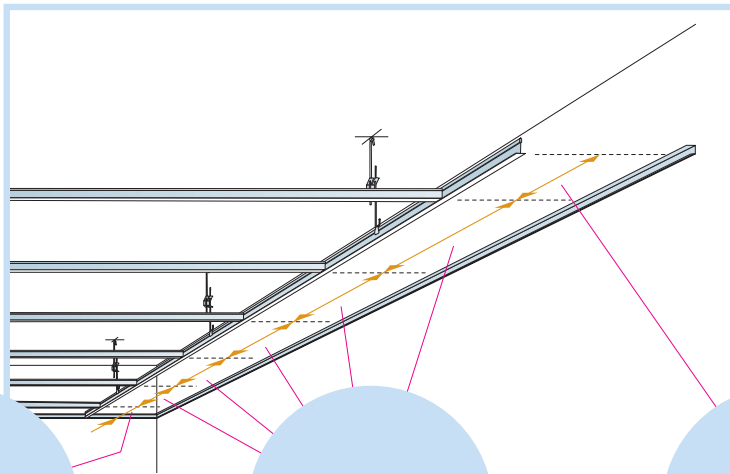
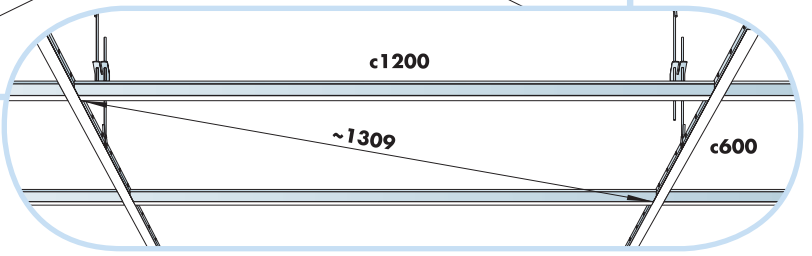
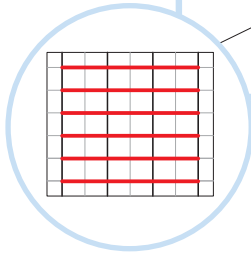

8₁

300-600

600

300-600

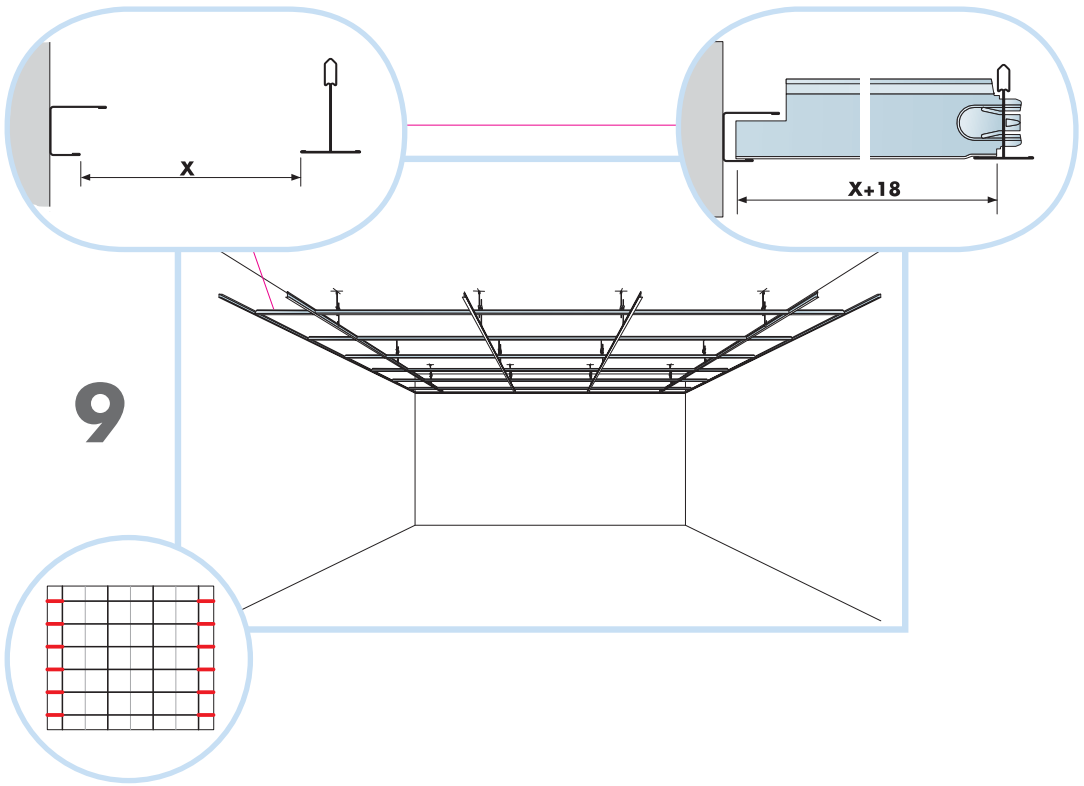

600x600 → 10
1200x600 → 15

600x600

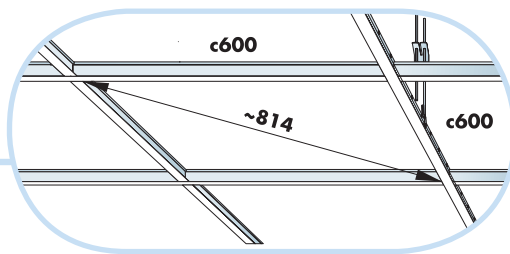
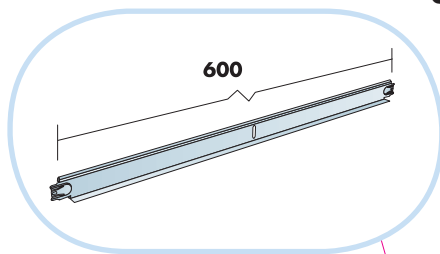

10

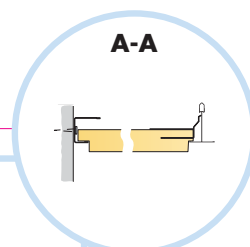
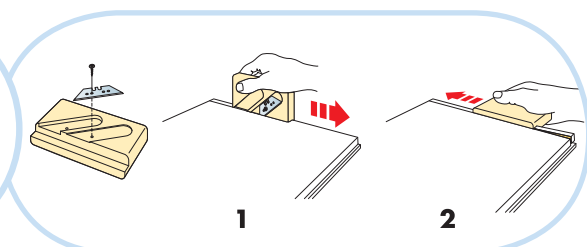
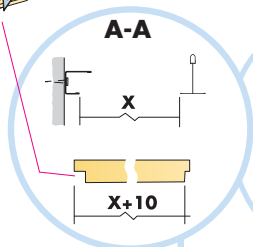
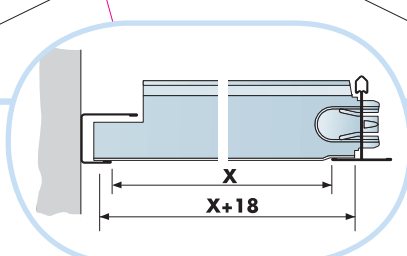
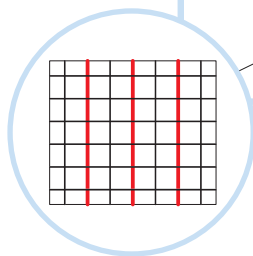
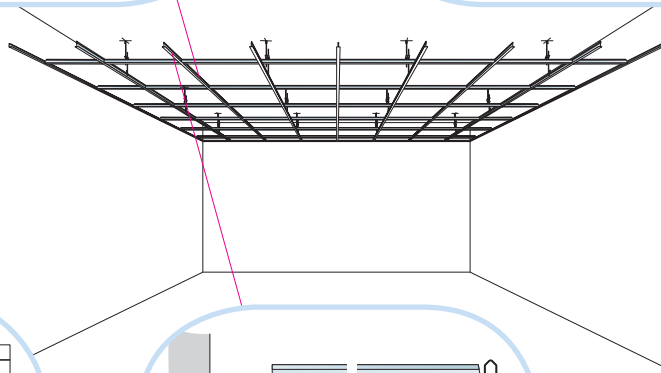

11

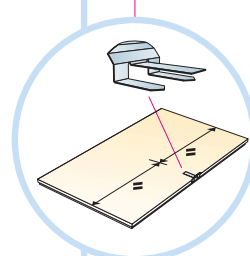
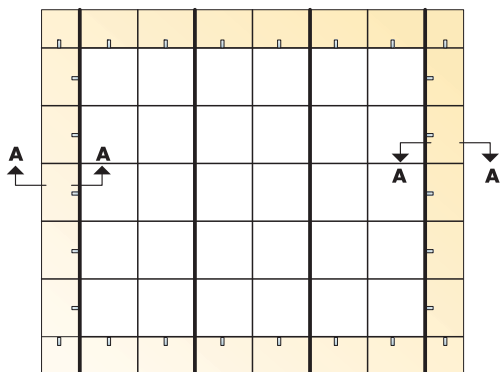
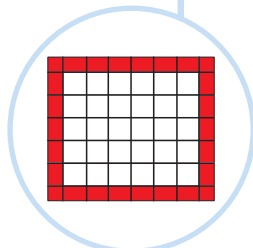

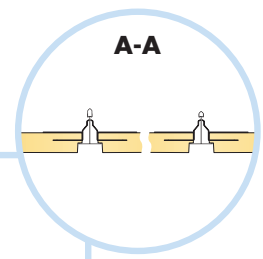
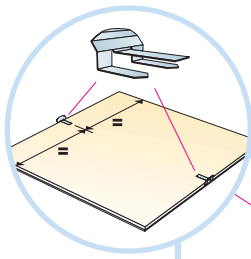

12

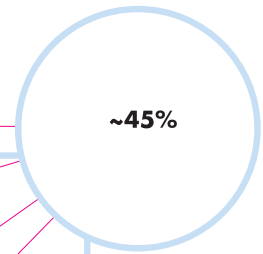
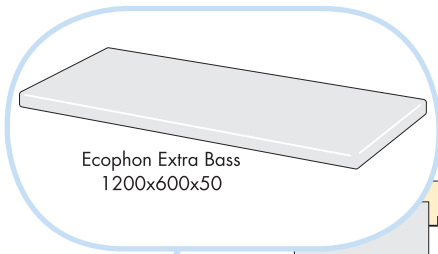
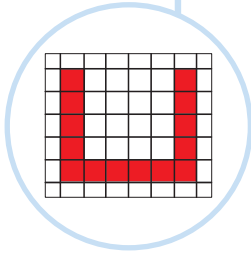
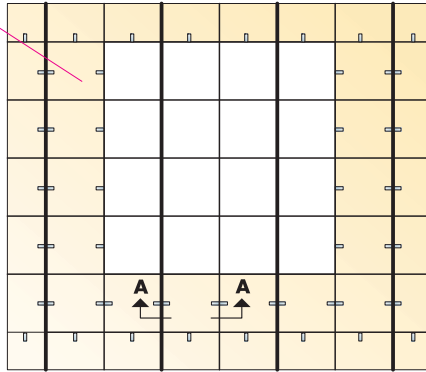

13

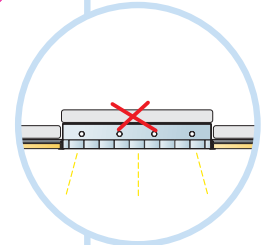
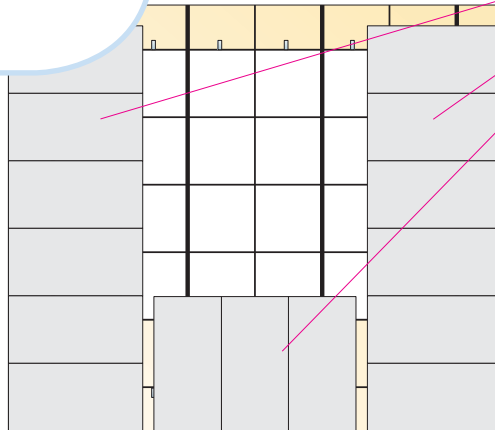

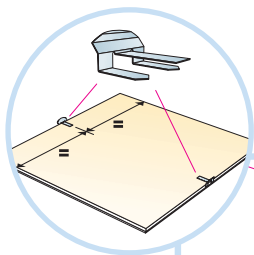

14

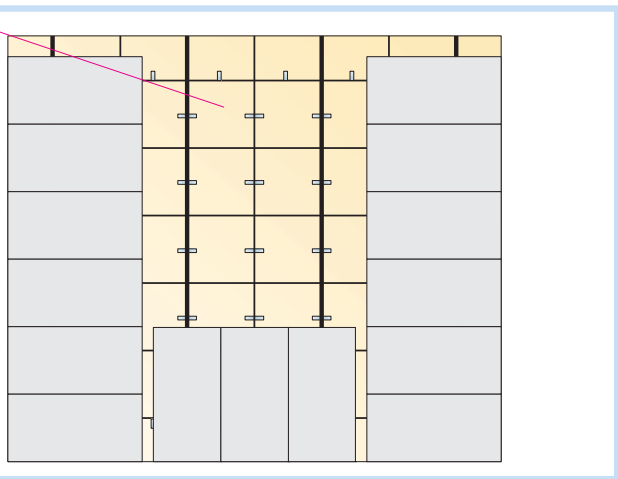
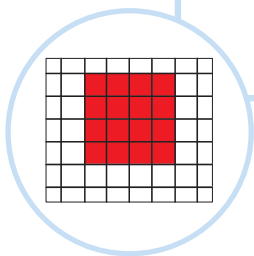

1200x600

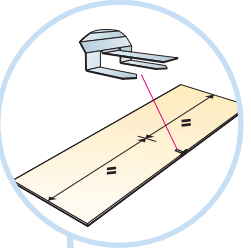
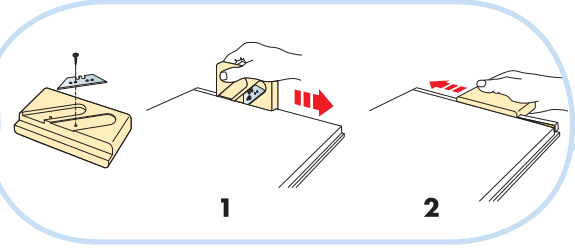
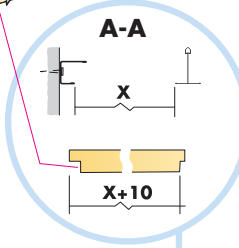

15

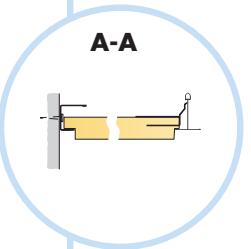
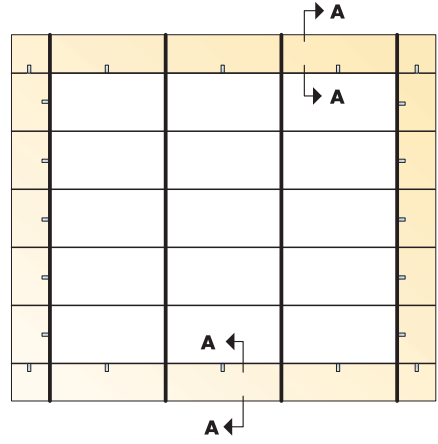
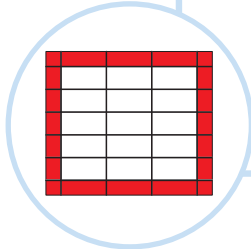

16

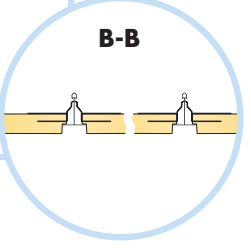
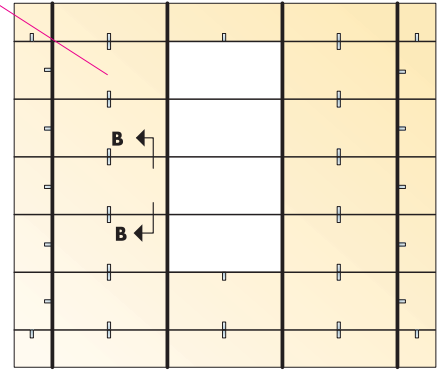
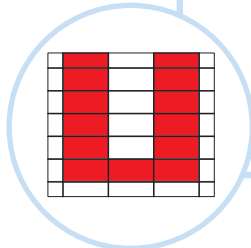
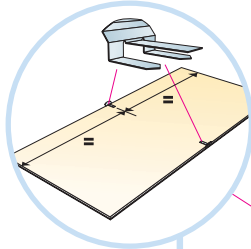

17

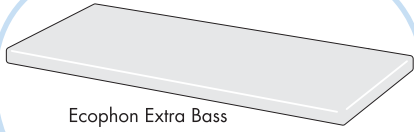

~45%

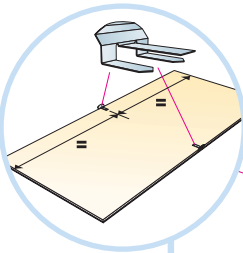
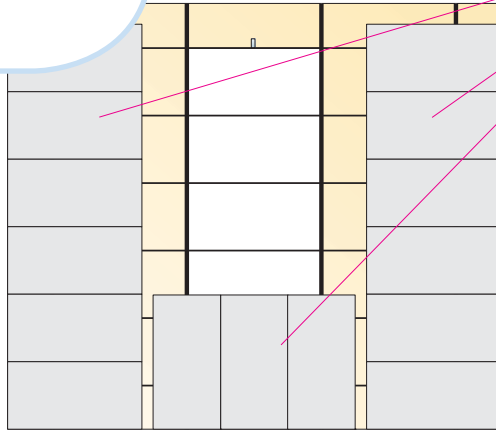
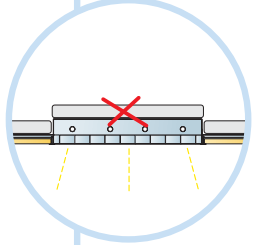

18

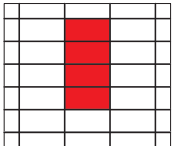
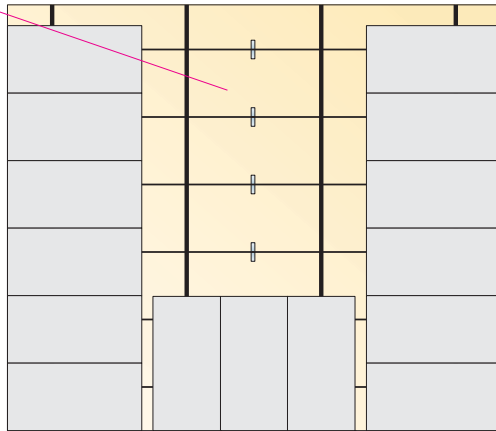

1200x1200

1200

A

A

19

$A \geq 600$

20

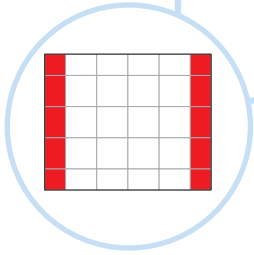

$A < 600$

19₁

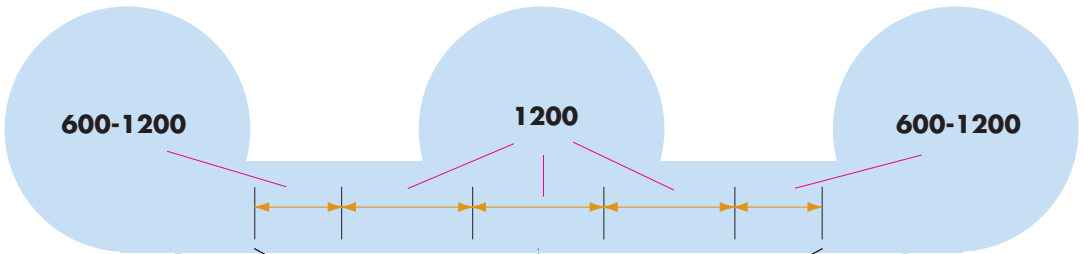

600-1200

1200

600-1200

19₁

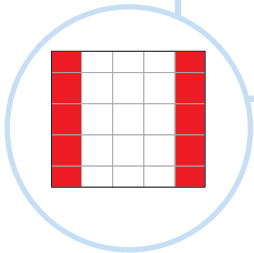

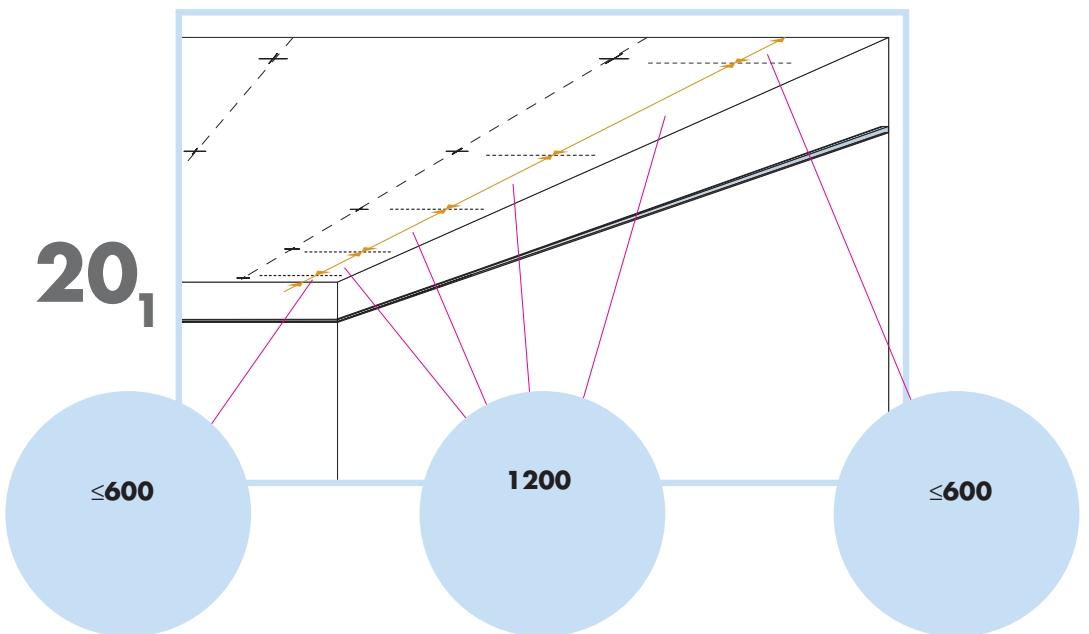
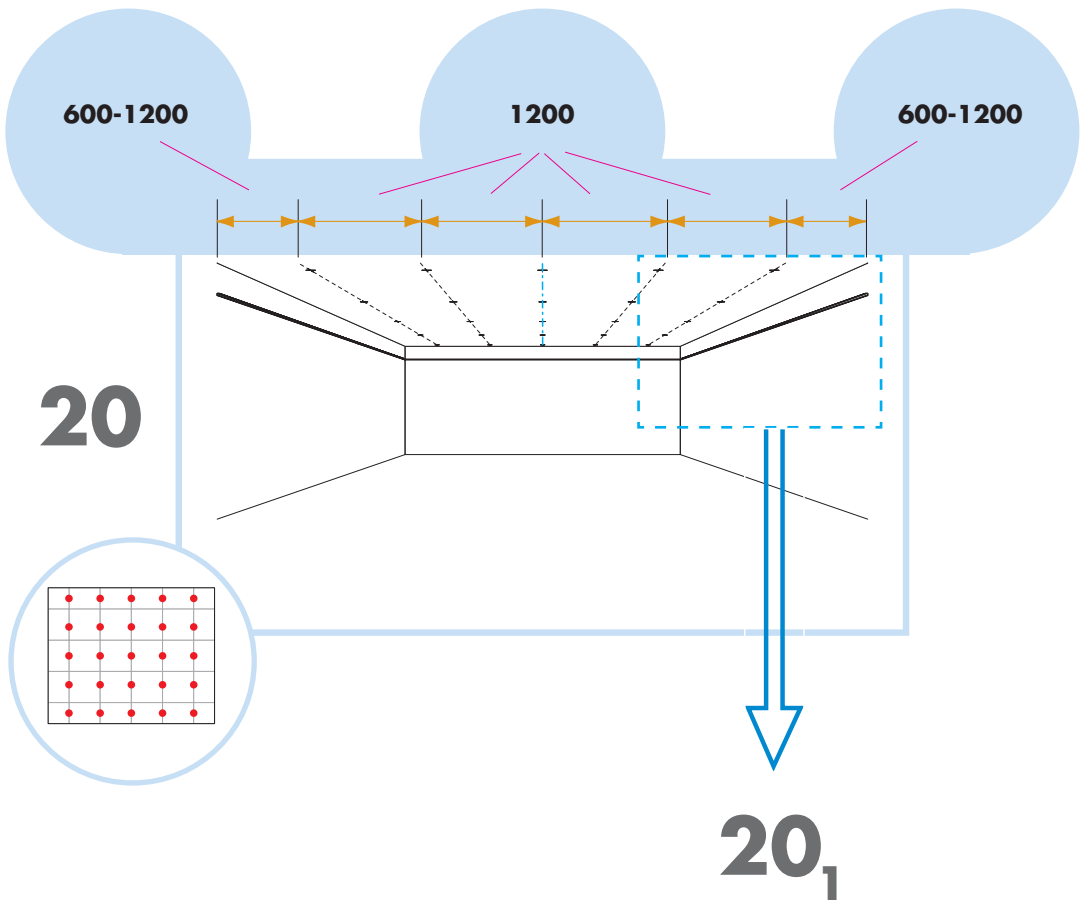

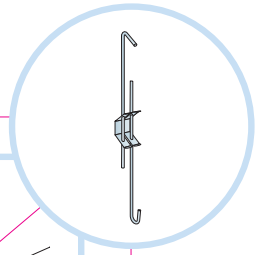
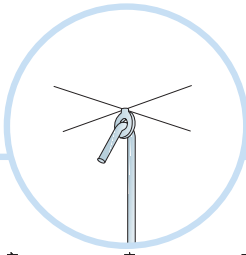
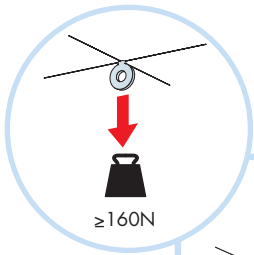

21

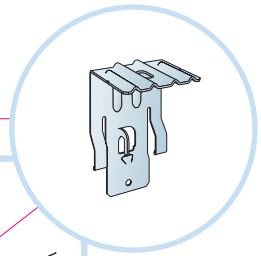
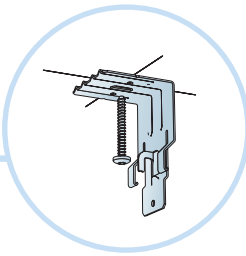
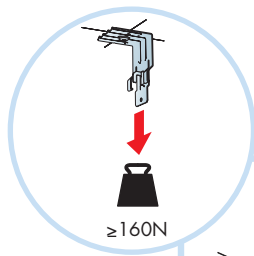
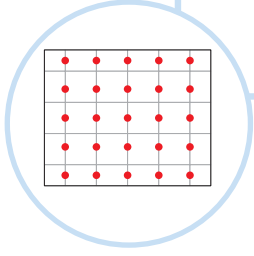
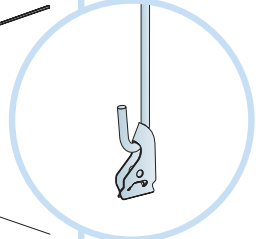
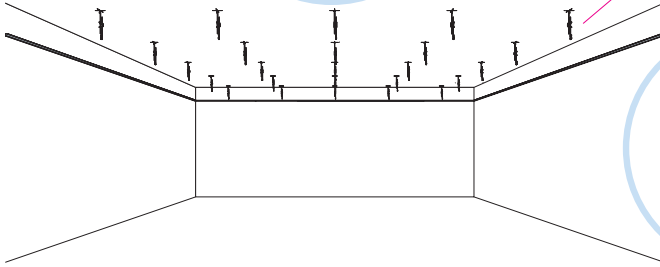

21₁

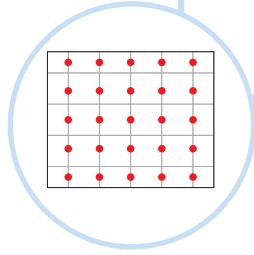
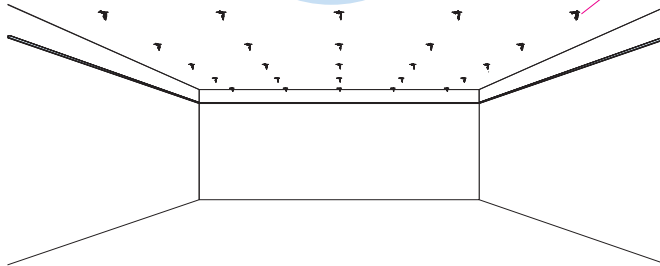

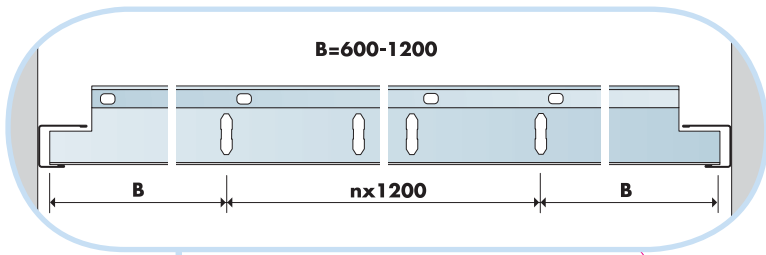

22

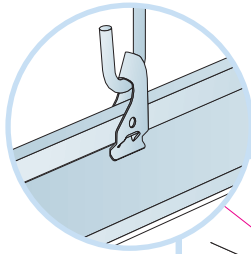
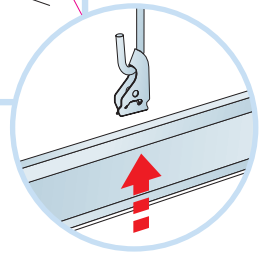
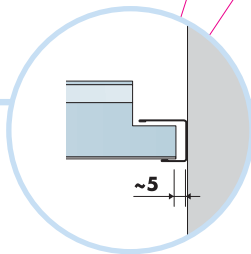
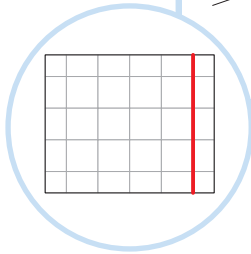
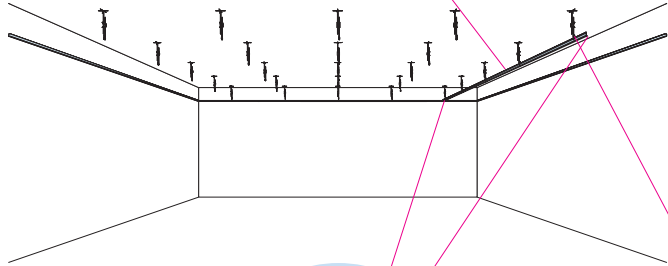

23

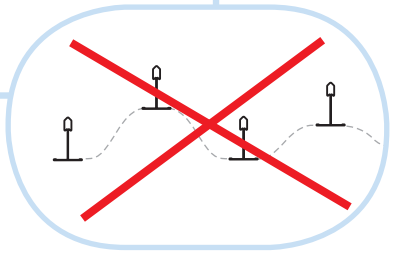
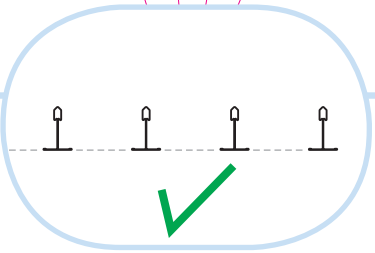
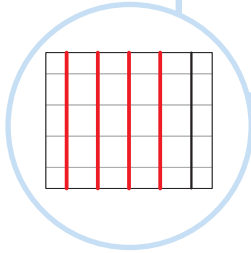
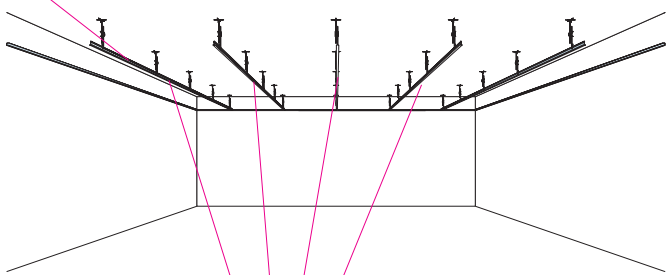

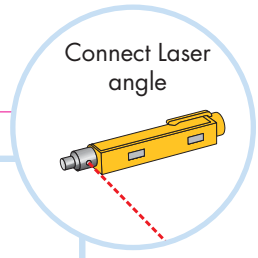
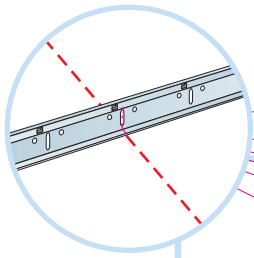

Connect Laser angle

23₁

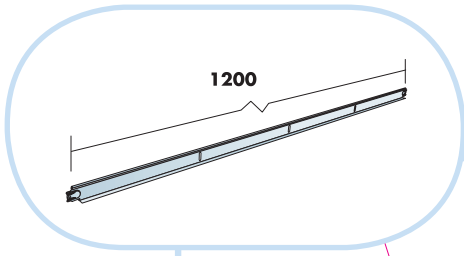
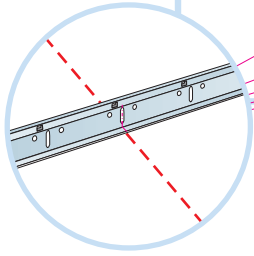
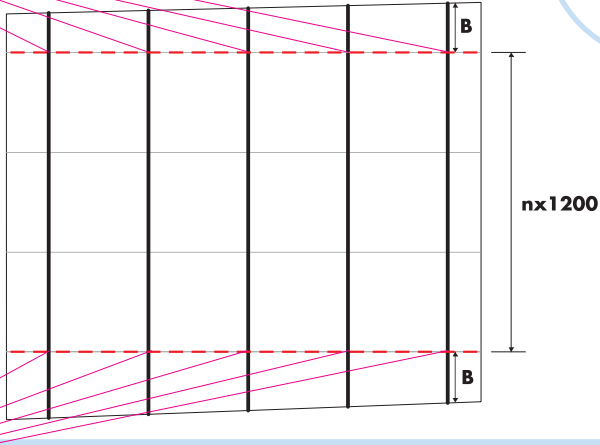

24₁

24

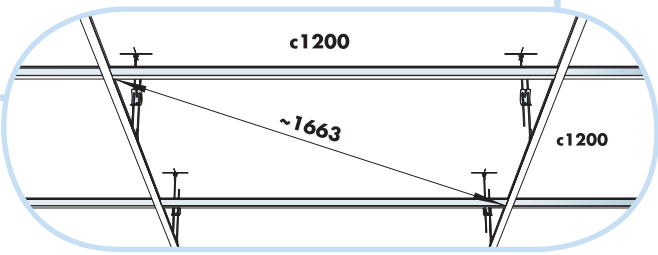
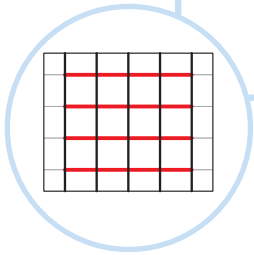
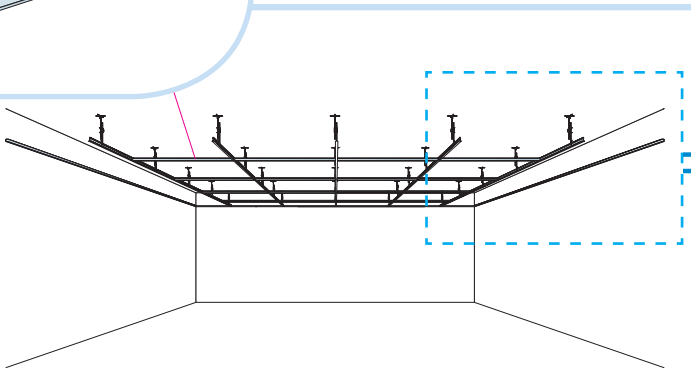

24,

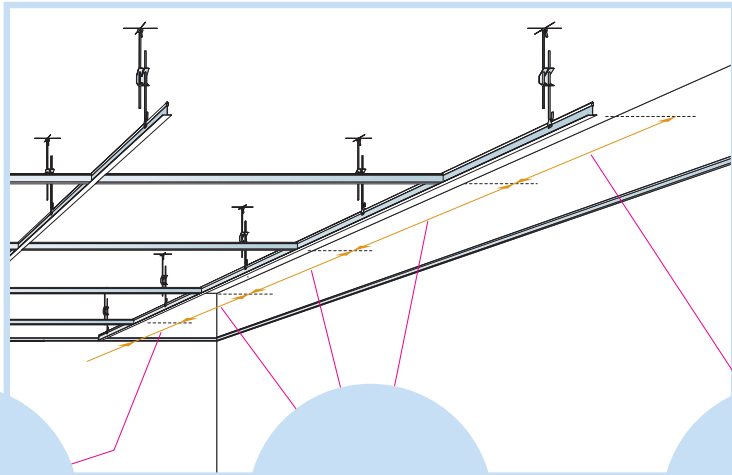

600-1200

1200

600-1200

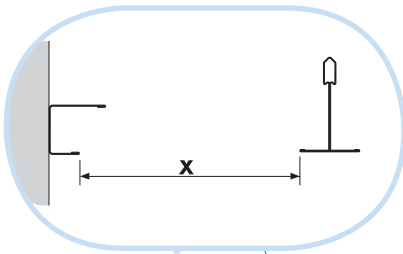

x

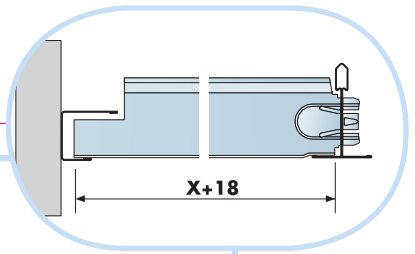

x+18

25

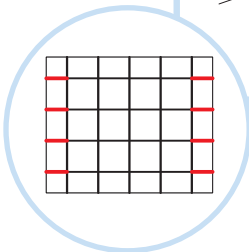
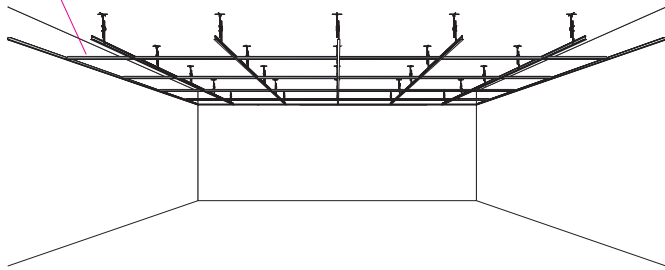

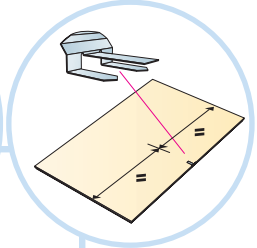
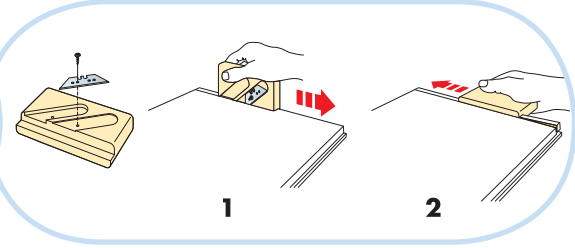
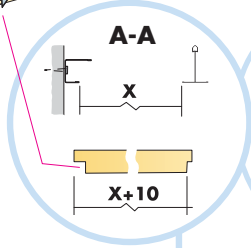

26

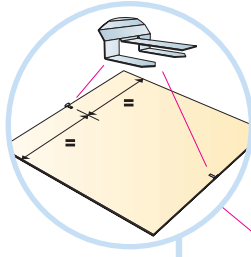
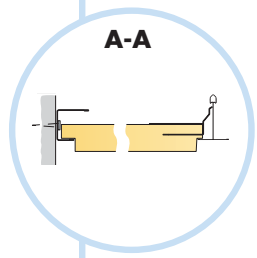
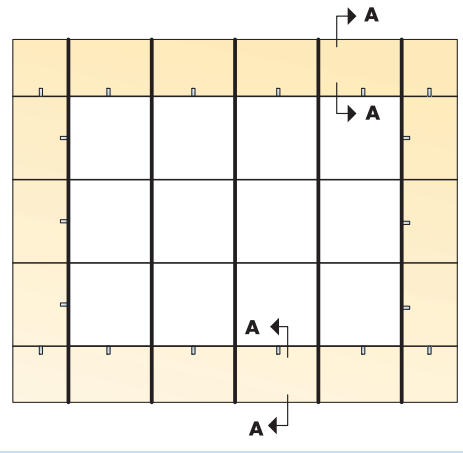
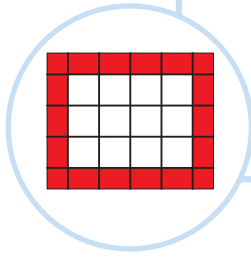

27

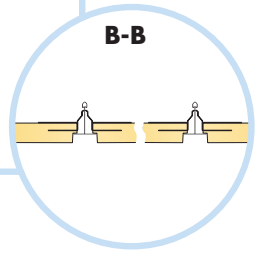
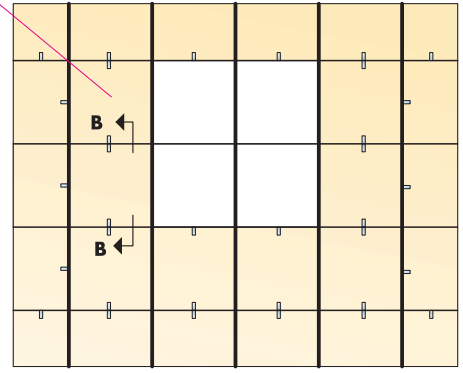
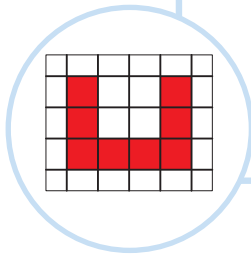

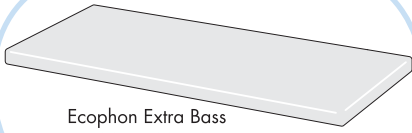

Ecophon Extra Bass
1200x600x50

~45%

28

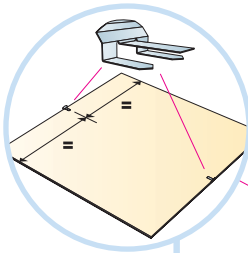
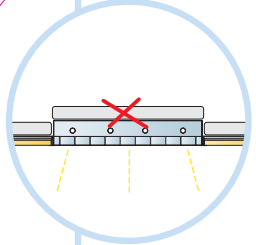
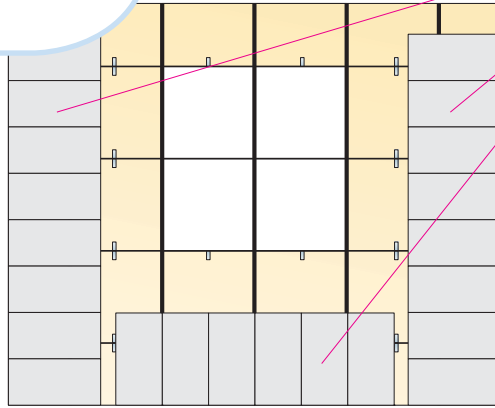

29

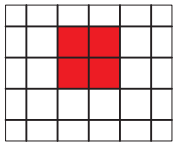
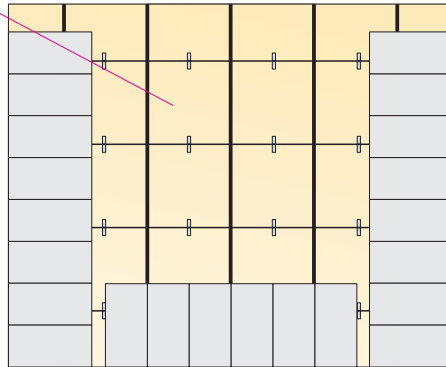

Demounting
600x600 → 30
1200x600 → 31
1200x1200 → 32

