

Edge E system

600x600, 1200x600,
625x625, 1250x625
(Not valid for Combison)

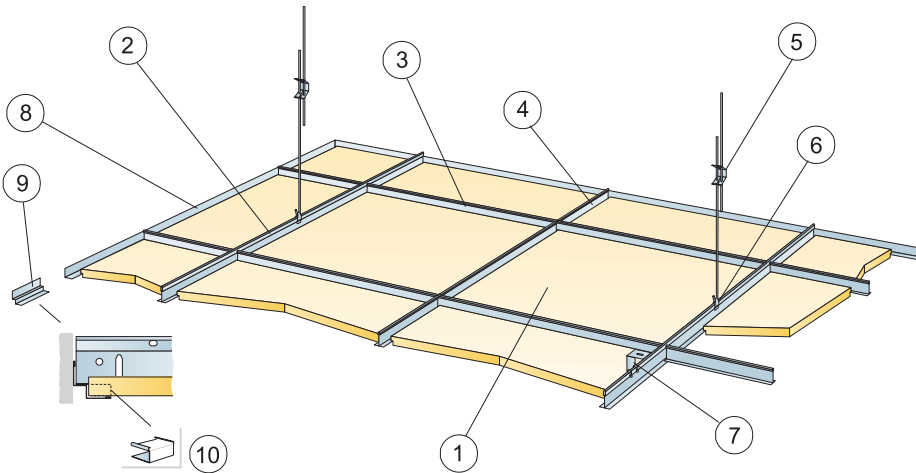
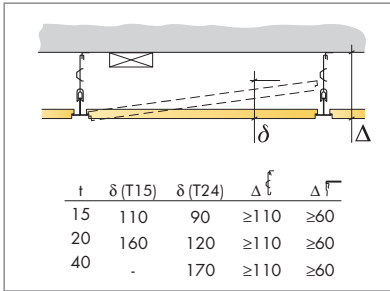

1. Ecophon edge E panel 600x600/1200x600
625x625/1250x625

2. Connect T24 or T15 Main runner

3. Connect T24 or T15 Cross tee,
L=1200/1250

4. Connect T24 or T15 Cross tee,
L=600/625

5. Connect Adjustable hanger

6. Connect Hanger clip

7. Connect Direct fixing bracket

8. Connect Angle trim

9. Connect Shadow-line
trim

10. Connect E-plugg

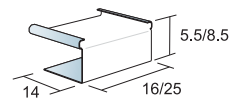
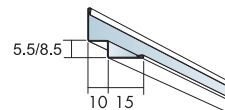
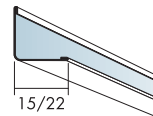

Ecophon[®]
SAINT-GOBAIN

A SOUND EFFECT ON PEOPLE

www.ecophon.com

3

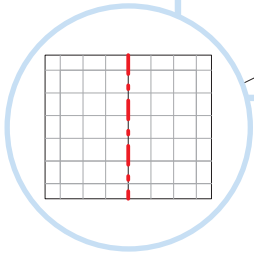
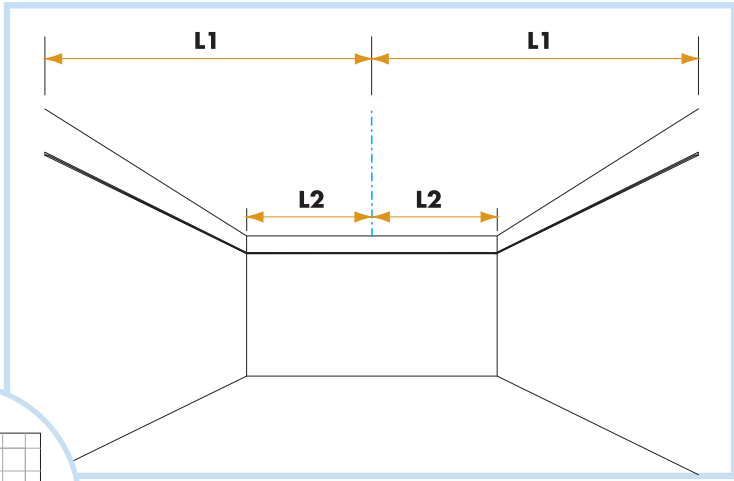

$A < 300$

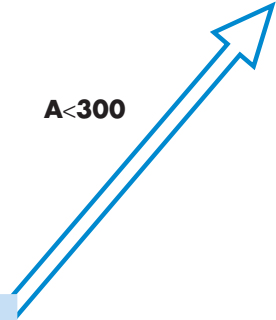

4

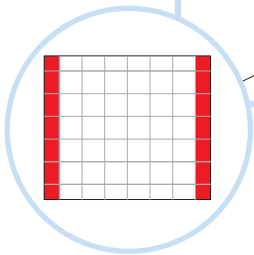
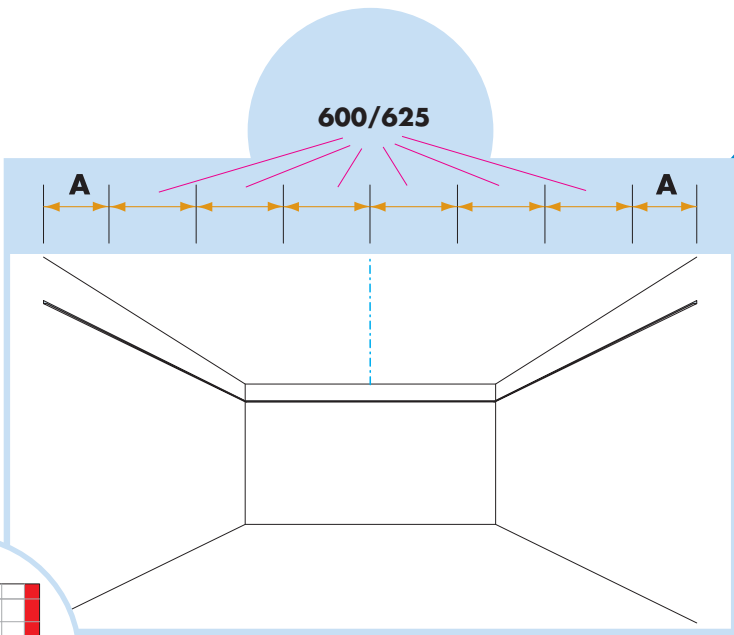

$A \geq 300$



5

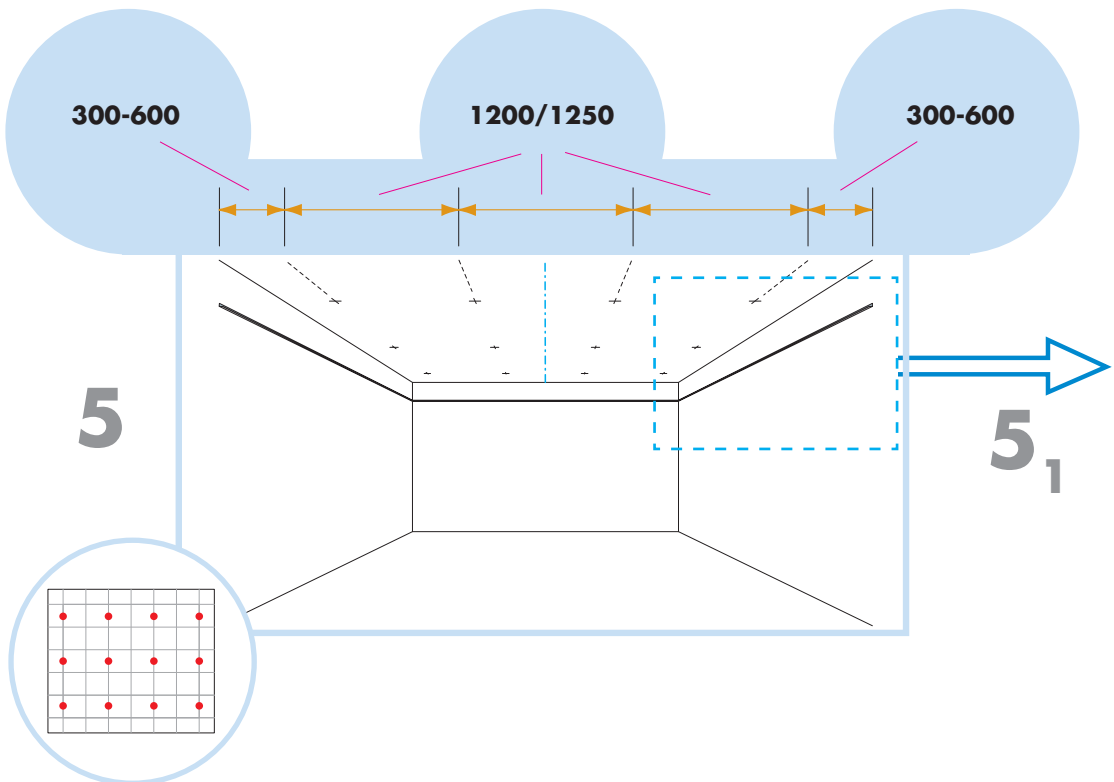
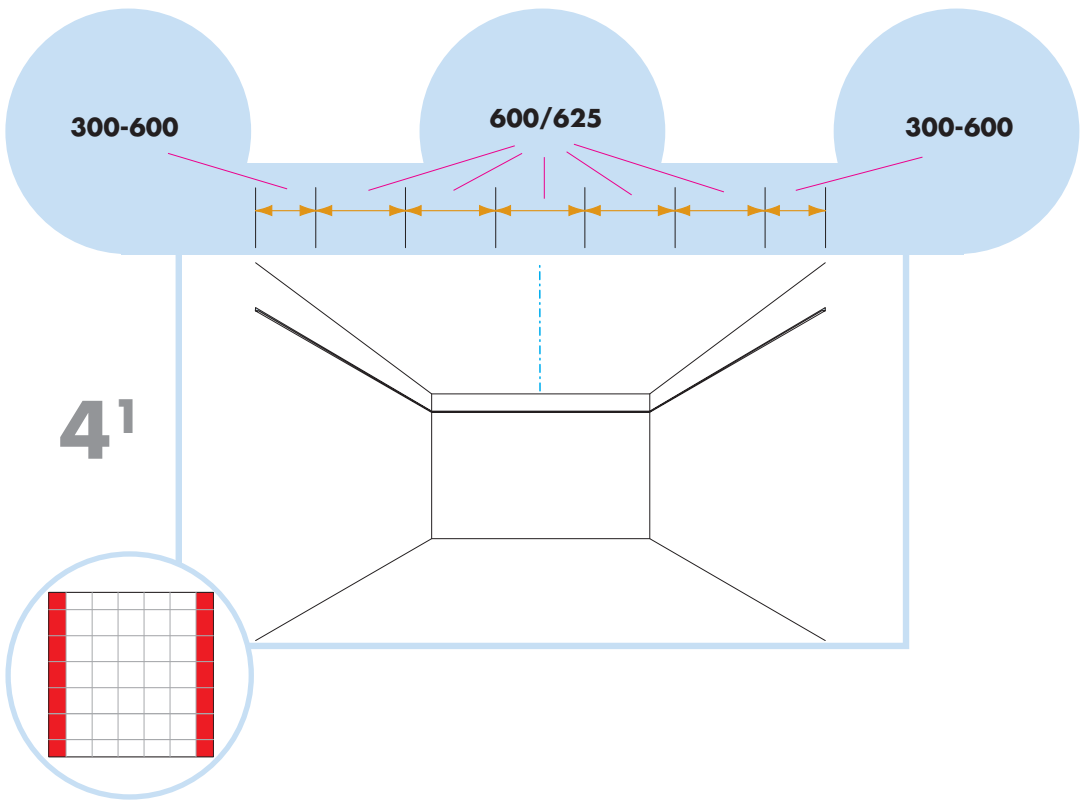

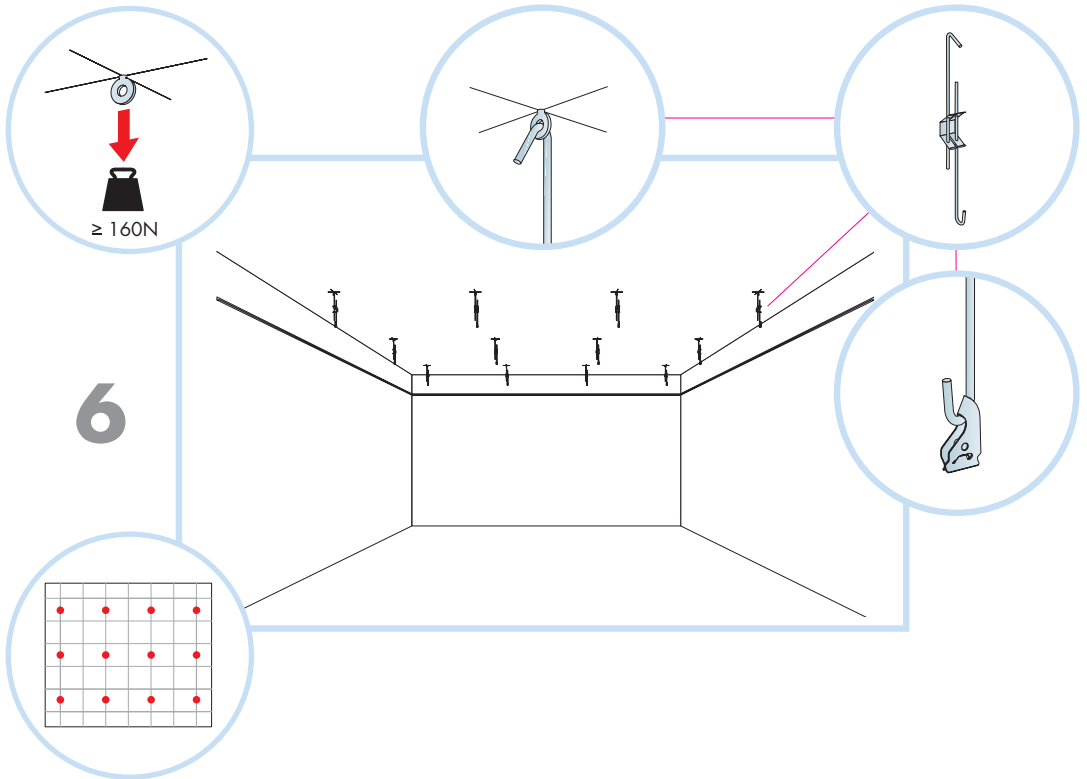
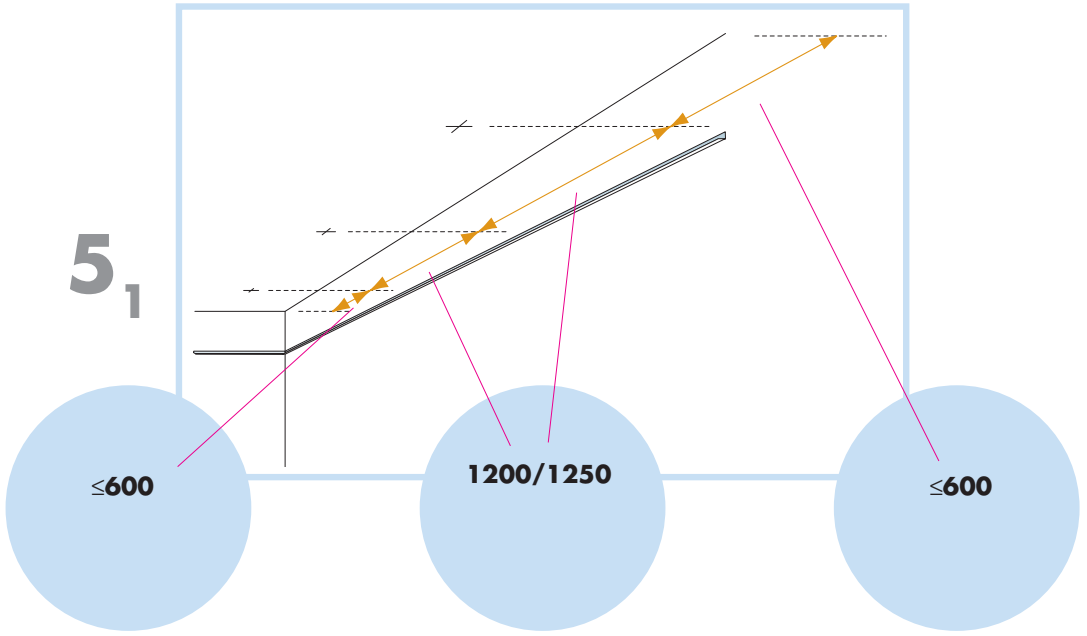

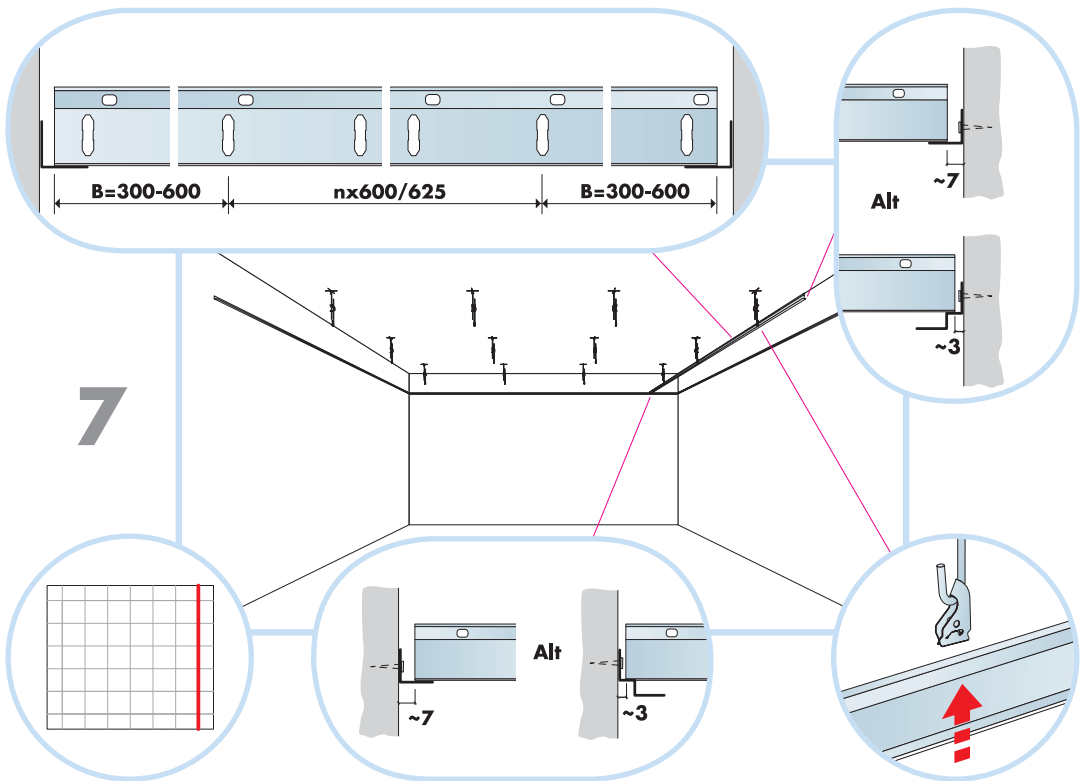
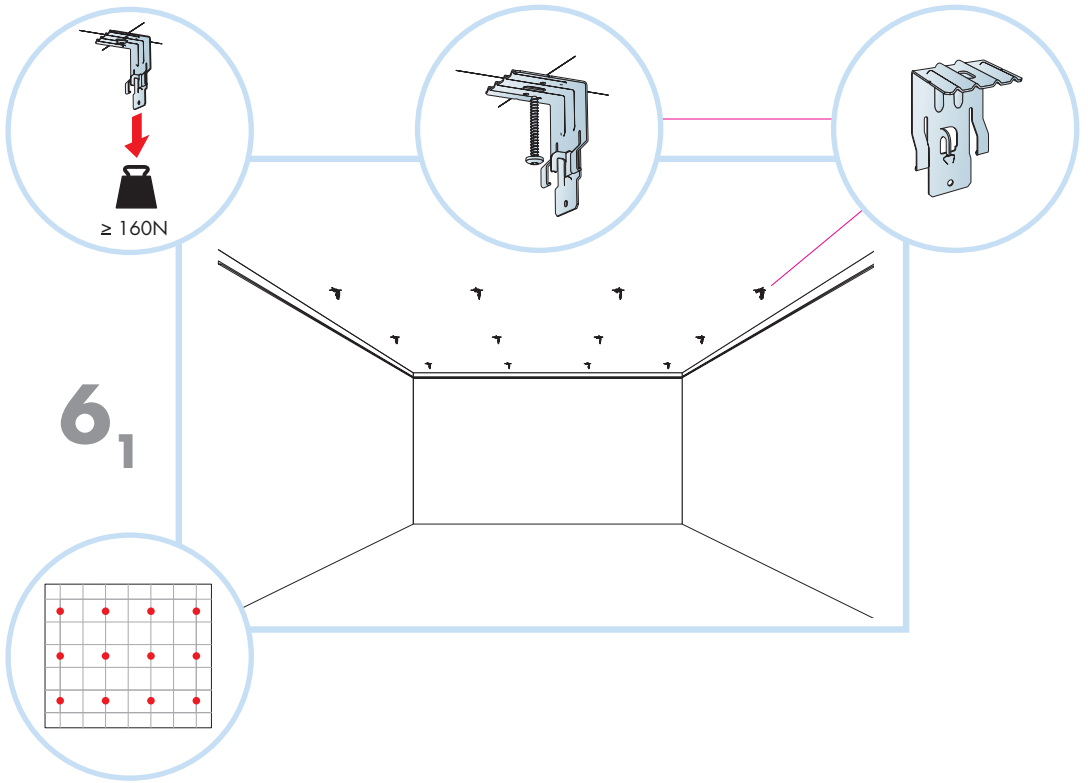

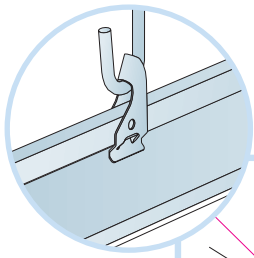

8

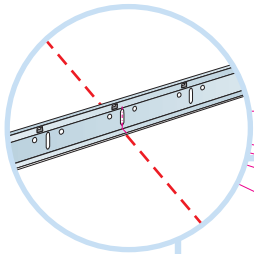
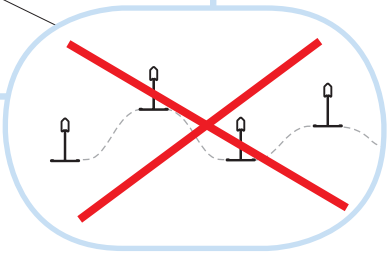
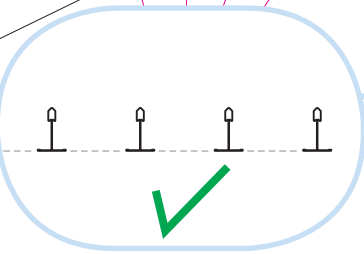
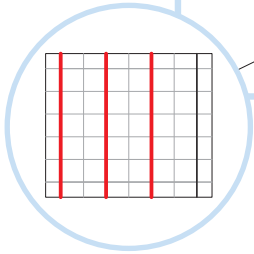
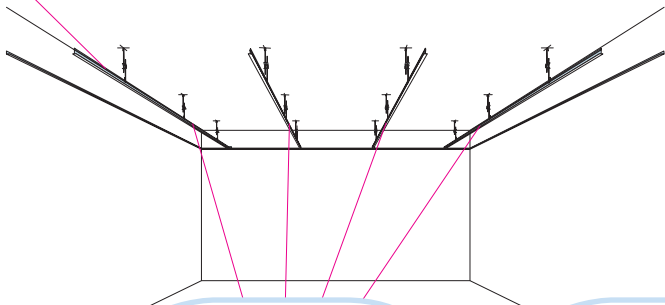

8₁

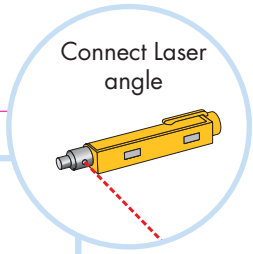
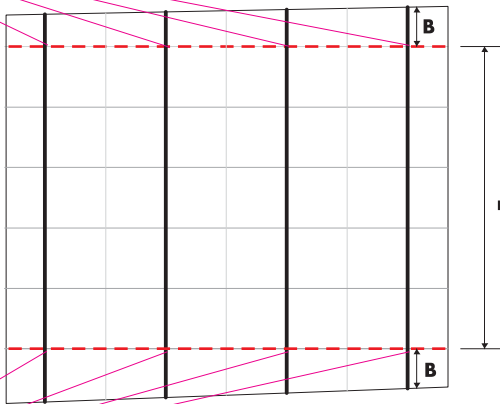

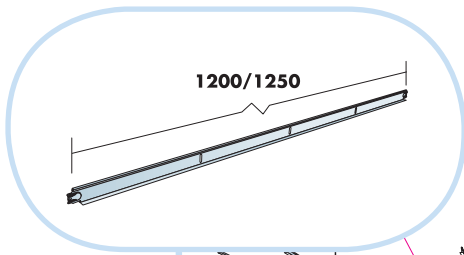

9

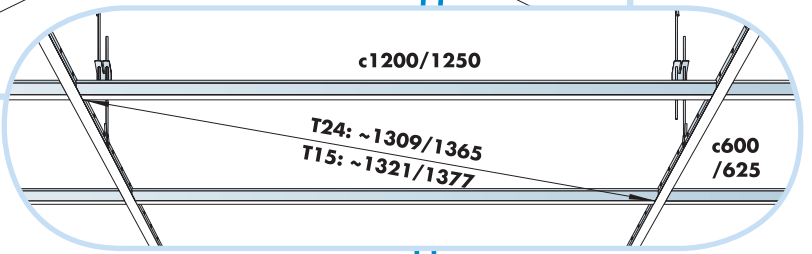
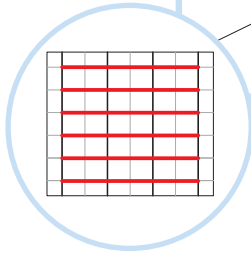
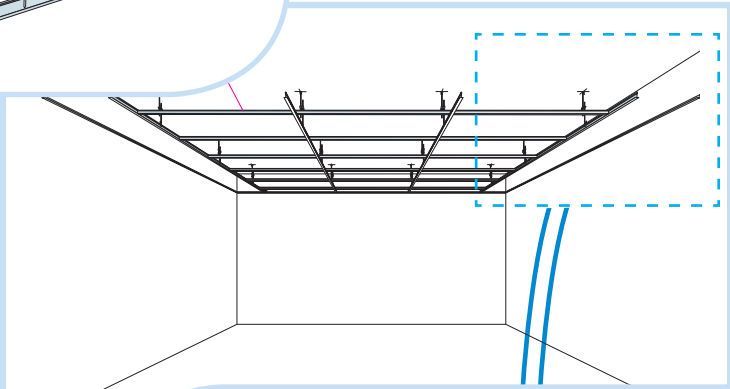

9₁



9₁

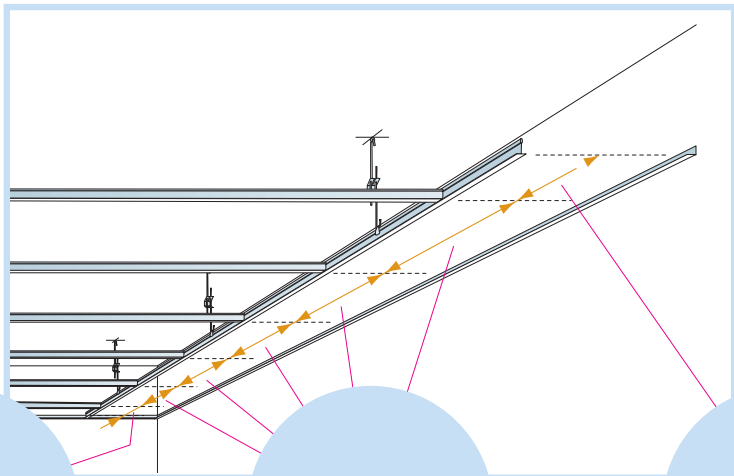

300-600

600/625

300-600

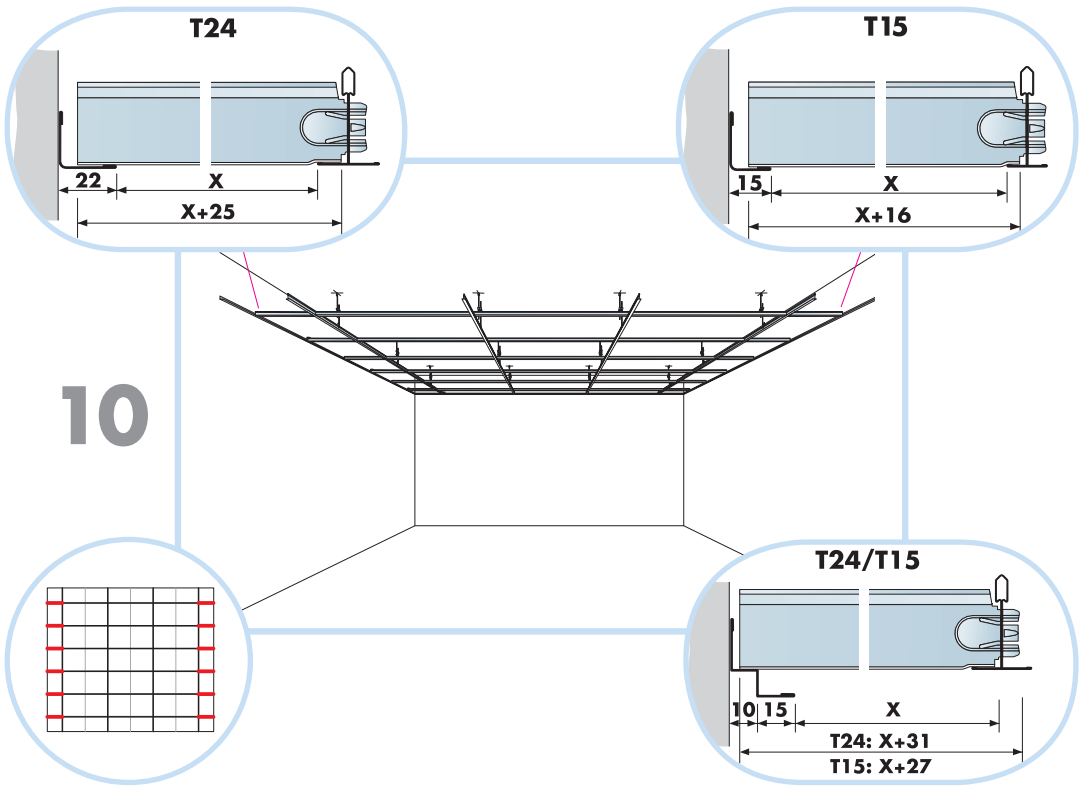

600x600/625x625 → 11
1200x600/1250x625 → 12

11

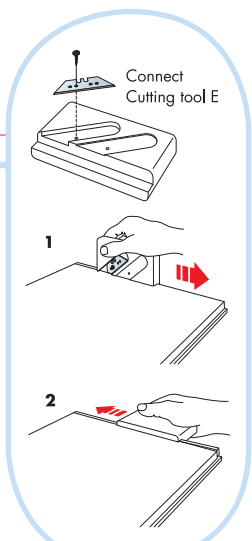
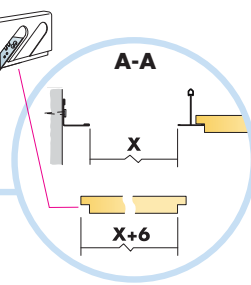
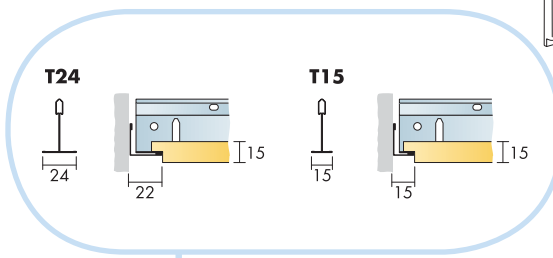
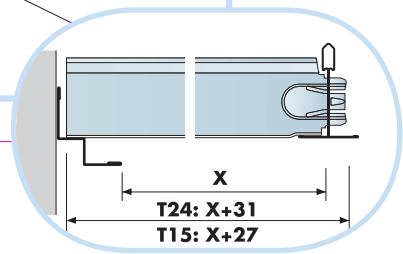
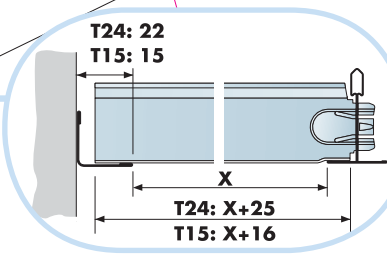
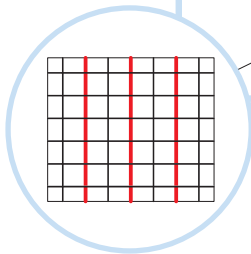
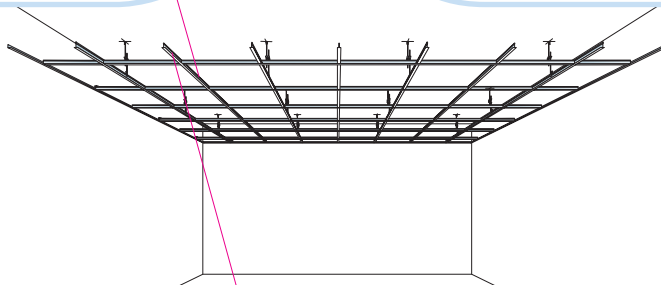
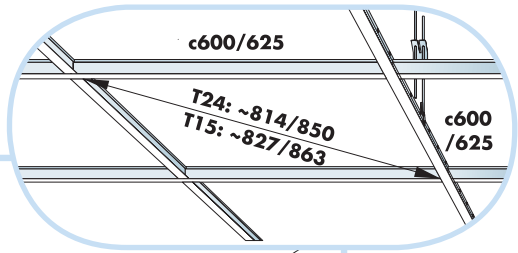
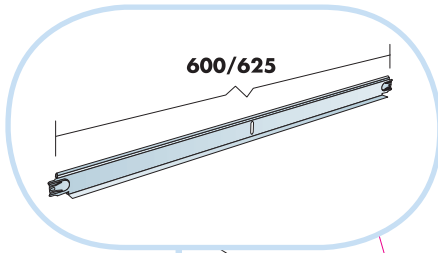

12

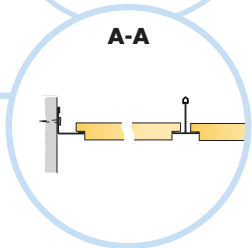
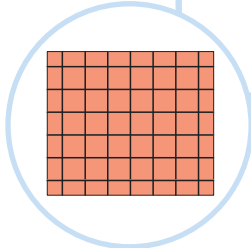
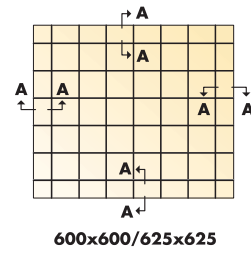
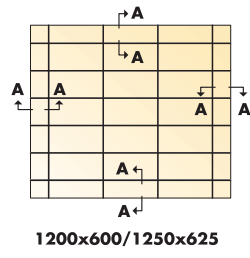

T24

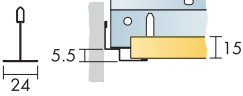

T15

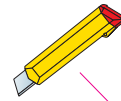
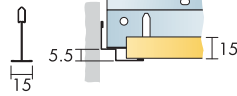

A-A

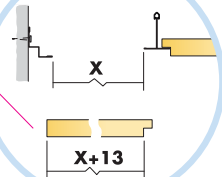

15
13

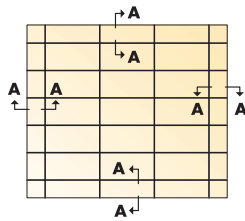

1200x600/1250x625

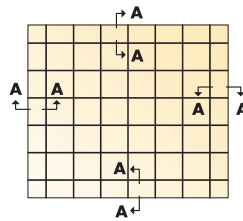

600x600/625x625

A-A

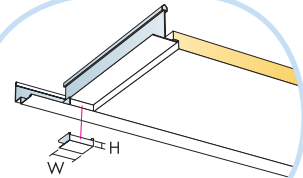
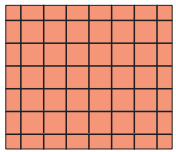
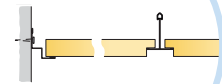

T24: H=5.5 W=25
T15: H=5.5 W=16

T24

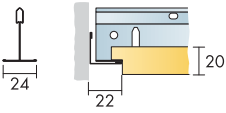

T15

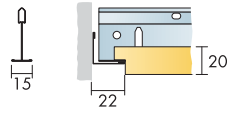

A-A

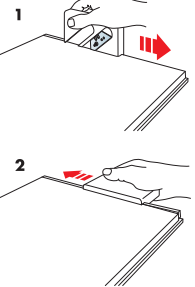
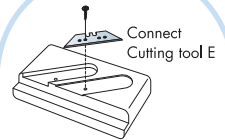
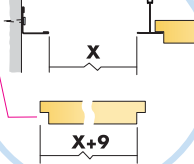

20
14

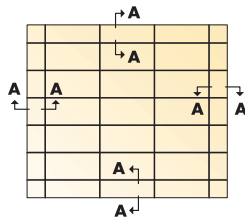

1200x600/1250x625

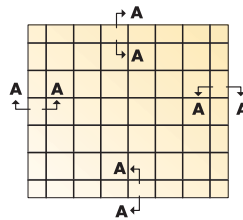

600x600/625x625

A-A

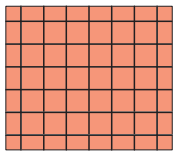
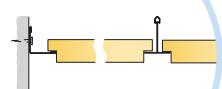

T24

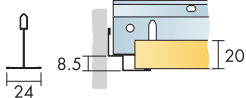

T15

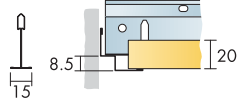

A-A

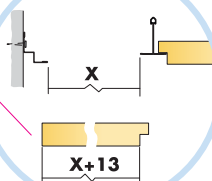

15

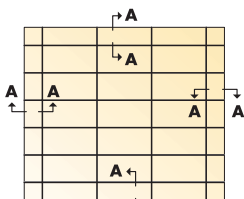

1200x600/1250x625

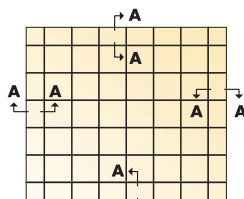

600x600/625x625

A-A

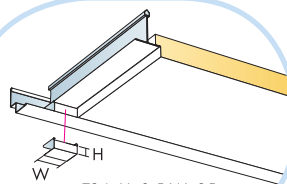
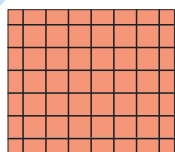

T24: H=8.5 W=25
T15: H=8.5 W=16

T24

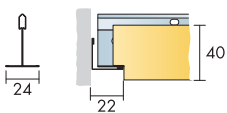

T15

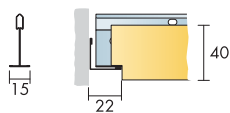

A-A

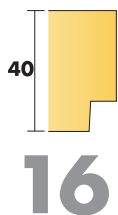
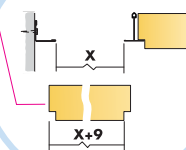

16

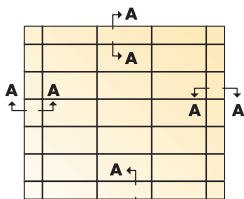

1200x600/1250x625

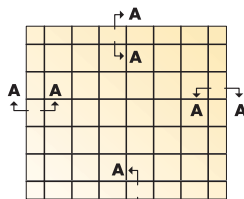

600x600/625x625

Connect Cutting tool E

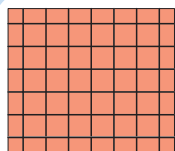
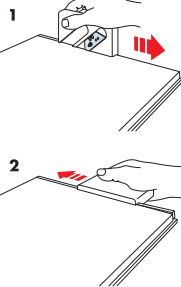
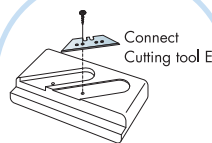

A-A



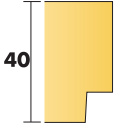
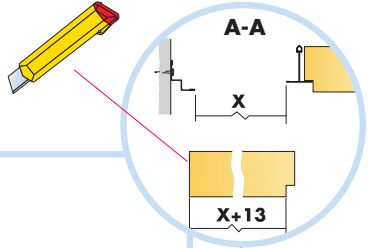
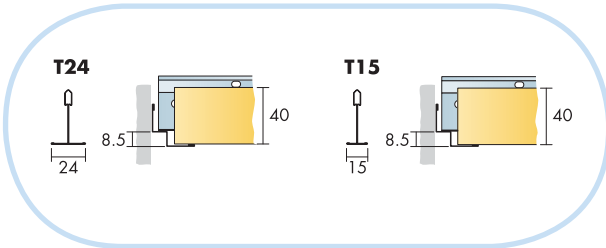

17

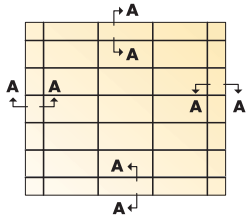

1200x600/1250x625

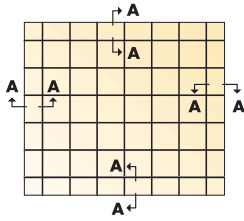

600x600/625x625

