

Focus frieze

2400x600, 24"x96"

M110

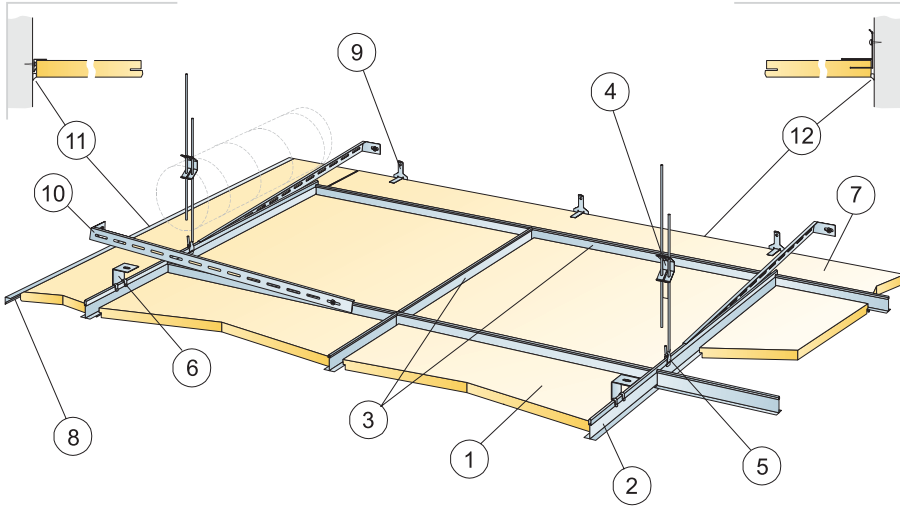
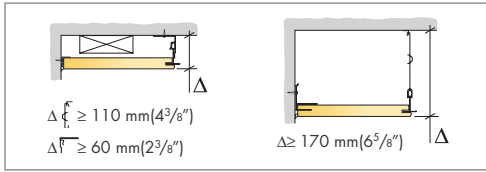

1. Focus/Master A or E

2. Connect T24 Main runner

3. Connect T24 Cross tees

4. Connect Adjustable hanger

5. Connect Hanger clip 1285

6. Connect Direct bracket

7. Focus frieze 2400x600/24"x96"

8. Connect Frieze trim 0562

9. Connect Frieze bracket 0043

10. Connect Wall bracket
Space bar 0525

11,12. Connect sealant 0046

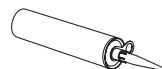
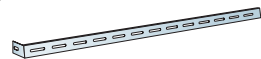
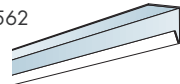
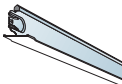
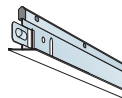

M=100-600(4-24")
N=100-600(4-24")

600(24")

2400(94")

$M, N \leq 300(12")$
 $M, N \leq 300(12")$

1

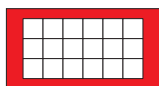
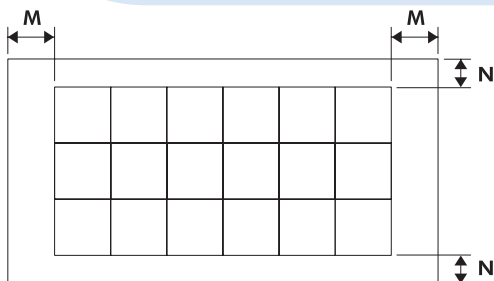

600(24")

2400(94")

$M, N > 300(12")$

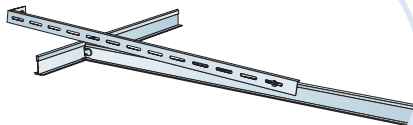

2

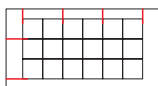
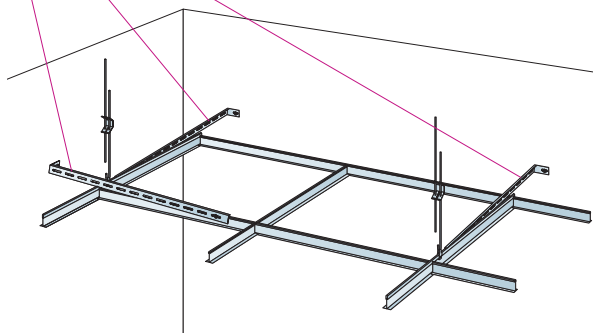

3

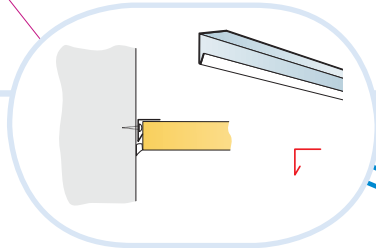
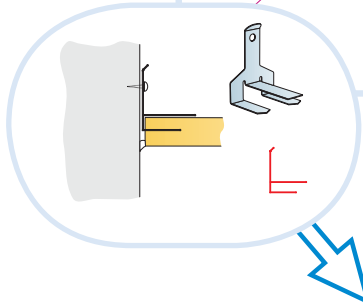
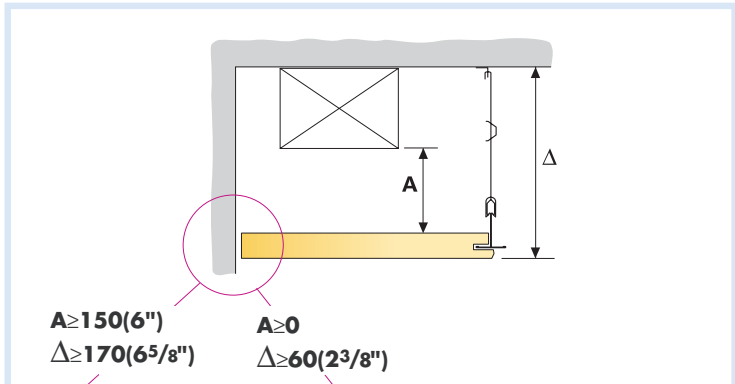

8

4

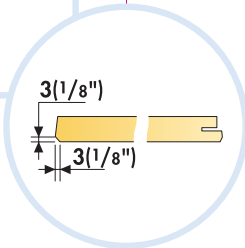
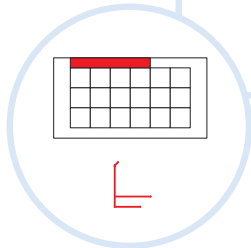
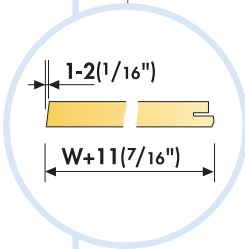
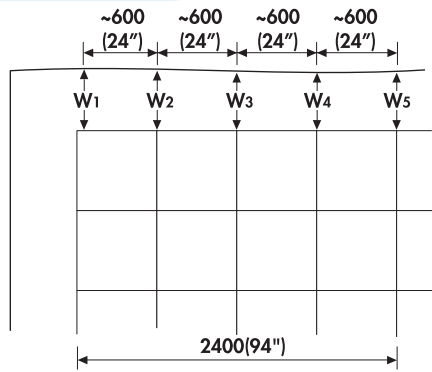
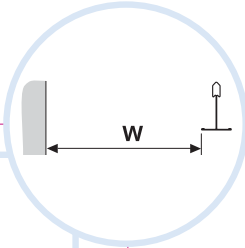
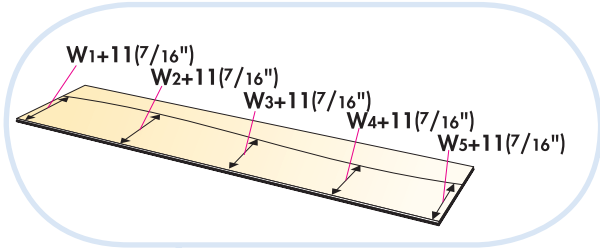

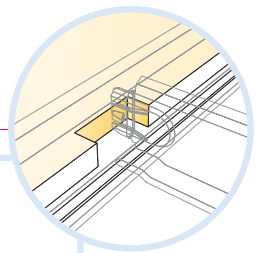
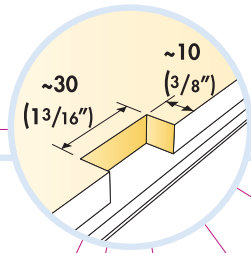
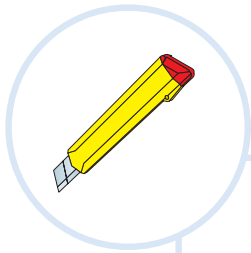

5

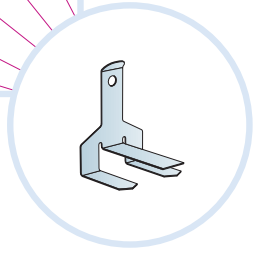
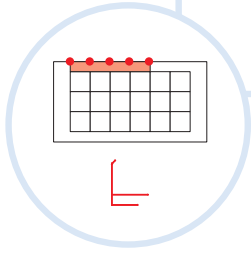
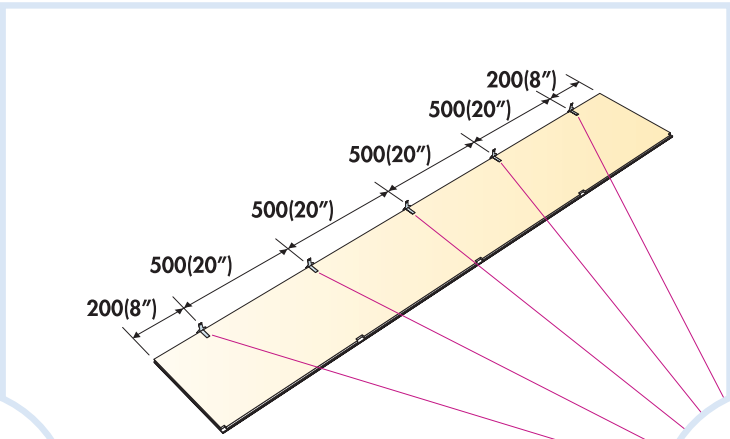
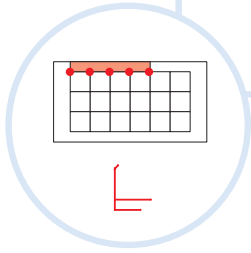
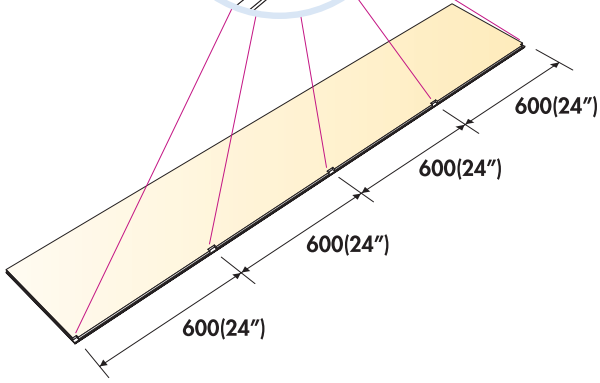

6

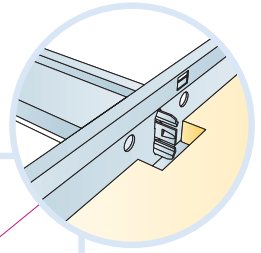
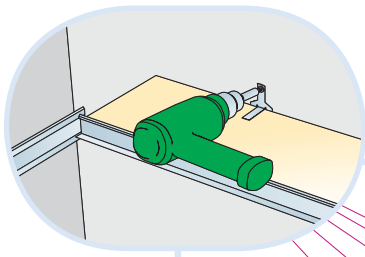

7

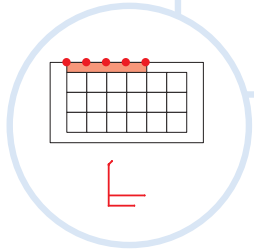
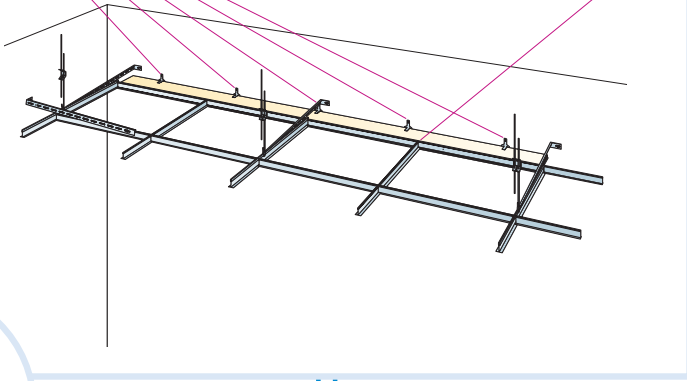

12

C300(12")

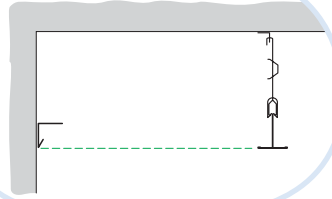
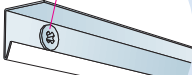

8

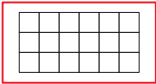
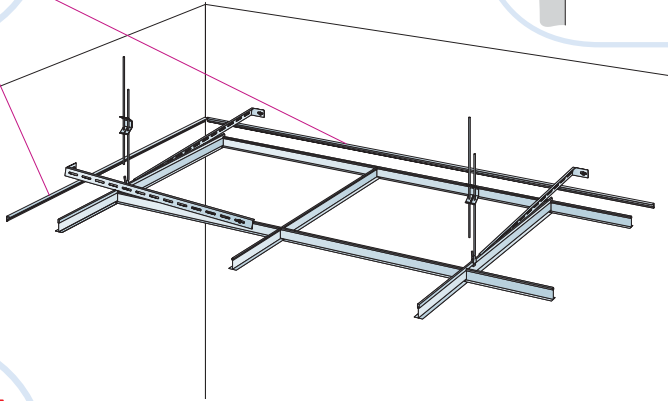

$W_1 - W_5 + 13(1/2")$

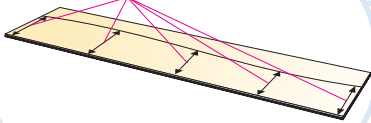

$W_1 - W_{14} + 13(1/2")$

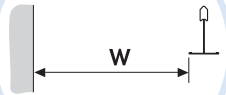
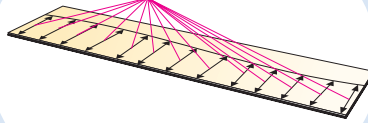

9

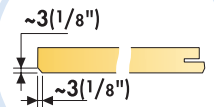
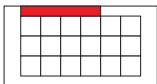
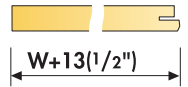
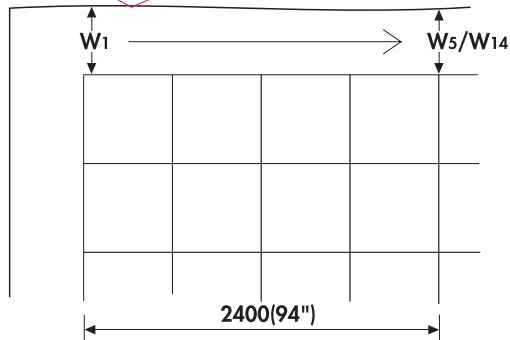

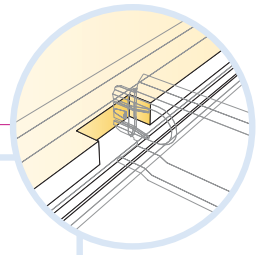
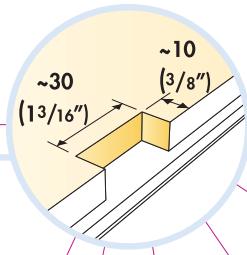
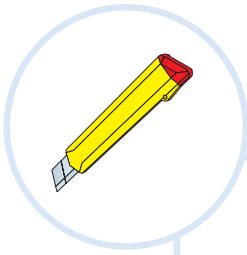

10

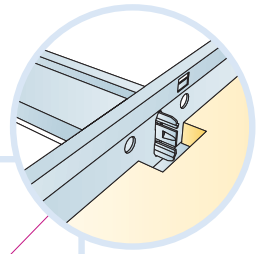
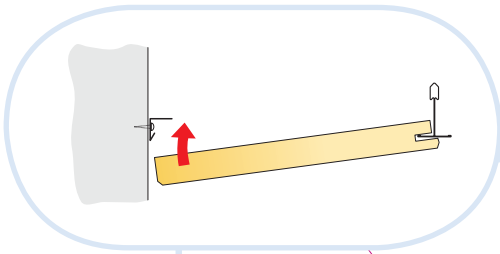
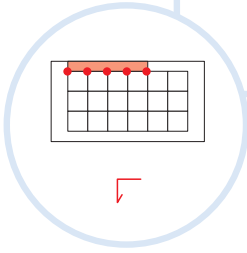
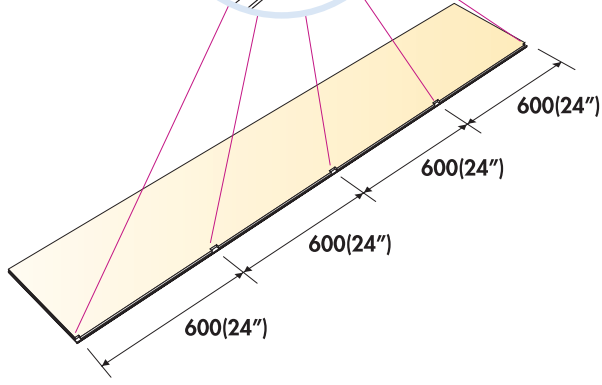

11

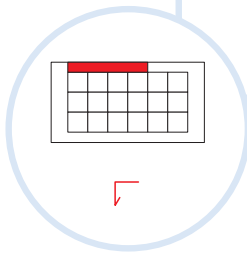
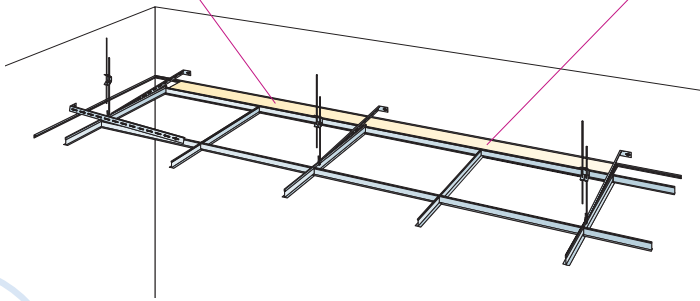

12

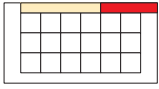
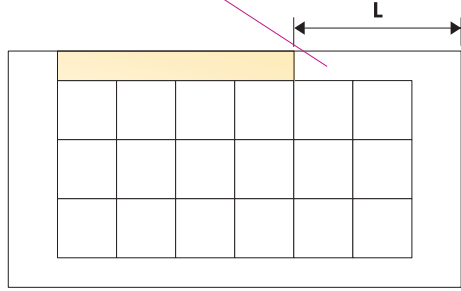
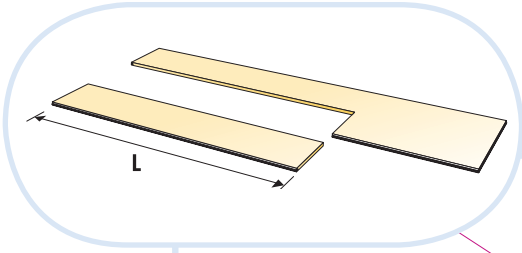

13

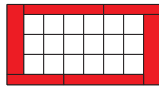
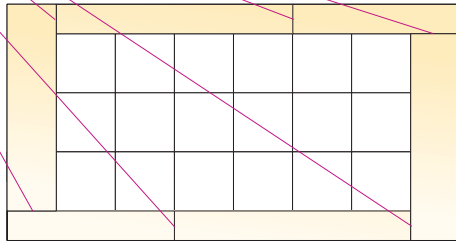
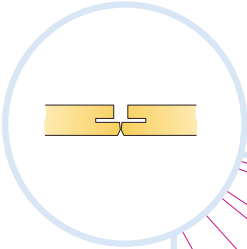

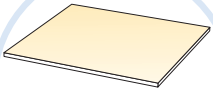

Focus A,E
Master A,E

14

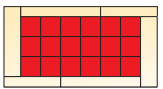
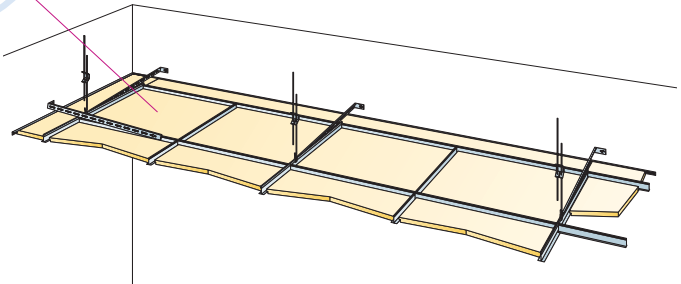

15

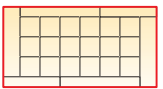
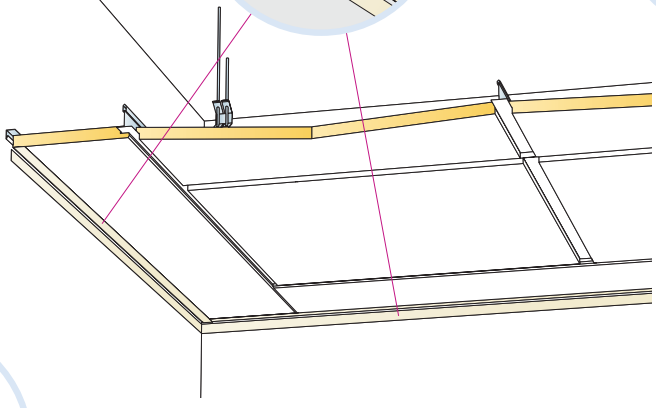
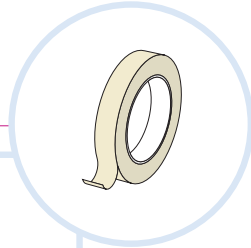
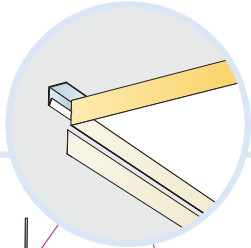

16

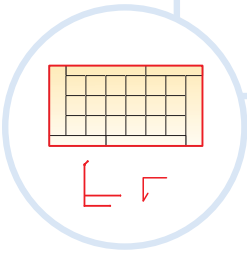
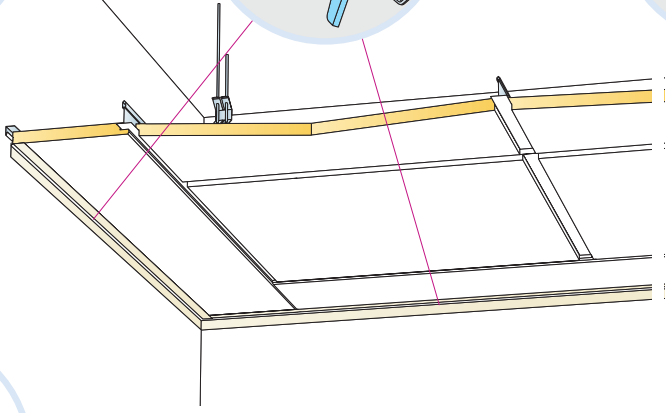
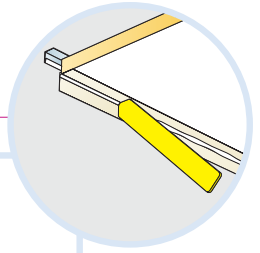
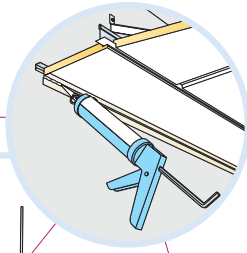
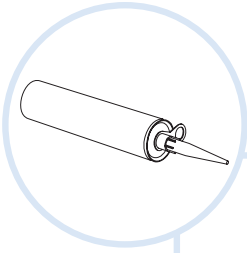

17

